

ARMOIRES ET PANNEAUX MURAUX

CABINETS AND WALL PANELS

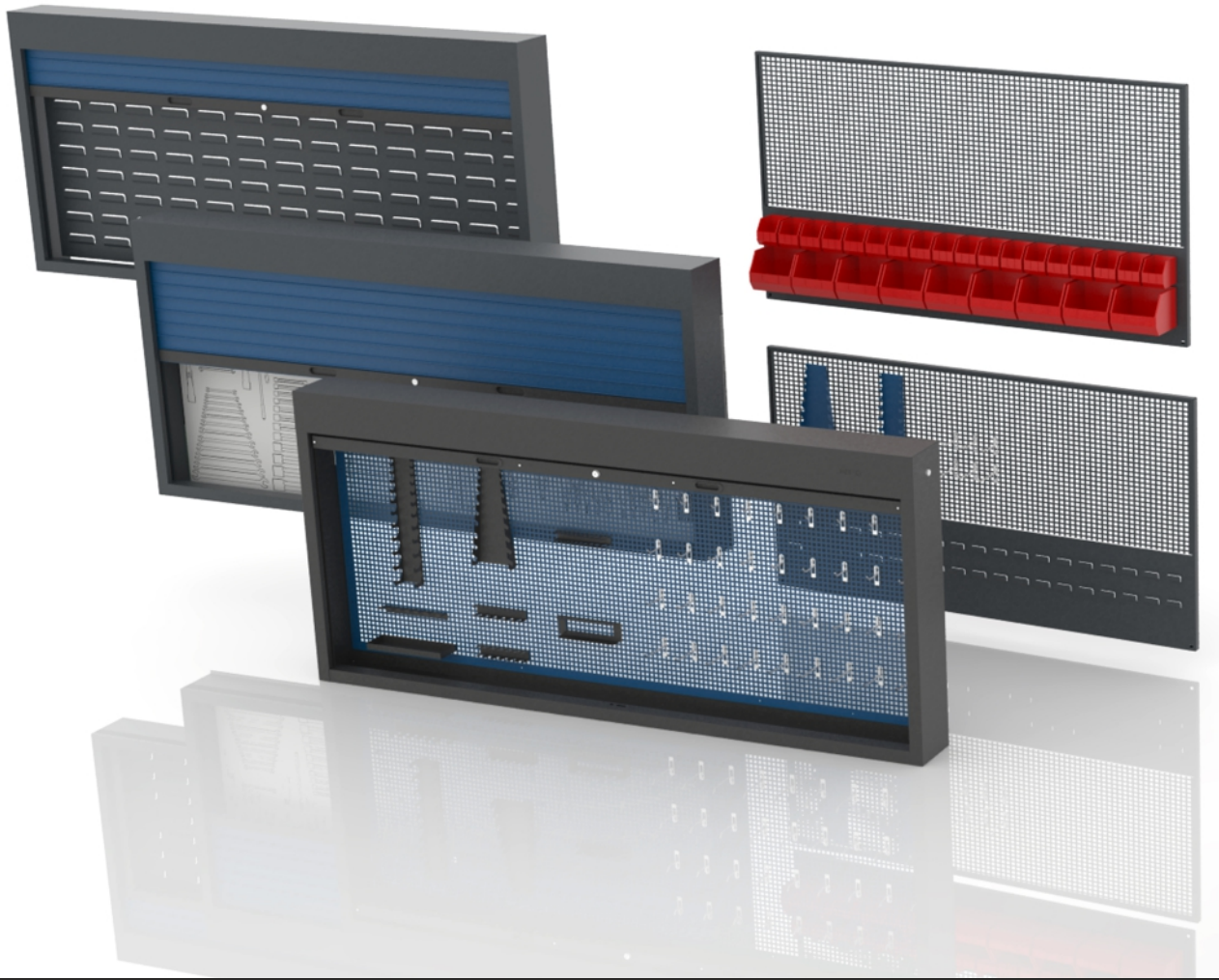

FR

- Grande variété de tailles et configurations.
- Conception robuste et résistante.
- Solutions de stockage d'outils.
- Accessoires disponibles pour la configuration.
- Les panneaux sérigraphiés permettent une plus grande capacité de stockage des outils.
- Couleur standard bleu martelé possibilité teintes en option.

EN

- Wide range of sizes and configurations.
- Strong and resistant design.
- Storage solutions for tools.
- Accessories available for customization.
- Printed designs offer large tool storage capacity.
- Standard colour hammered possibility optional colours.

## ARMARIOS Y PANELES MURALES

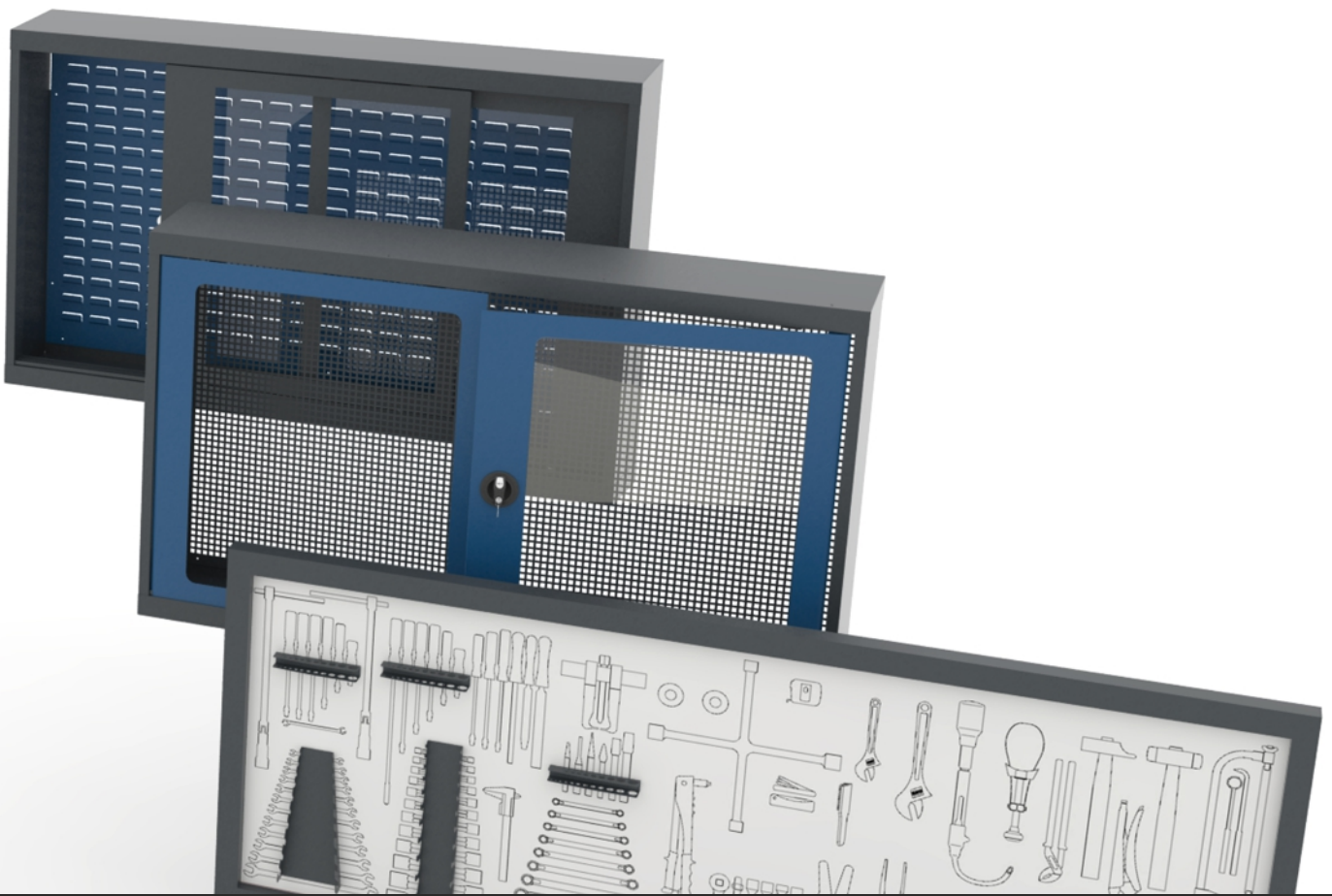

ES

- Gran variedad de medidas y configuraciones.
- Diseño robusto y resistente.
- Soluciones de almacenaje de herramientas.
- Accesorios disponibles para configuración.
- Los paneles serigrafiados ofrecen mayor capacidad de almacenaje de herramientas.
- Color opcional.





SERIE 109 ref. 109 10/13/15/18/20

PANELES PANNEAUX PANELS

Paneles de madera serigrafiados para herramientas.  
Panneaux en bois serigraphié pour outils.  
Screen printed wooden panels for tools.

Panel de madera.  
Panneau en bois.  
Wood panel.

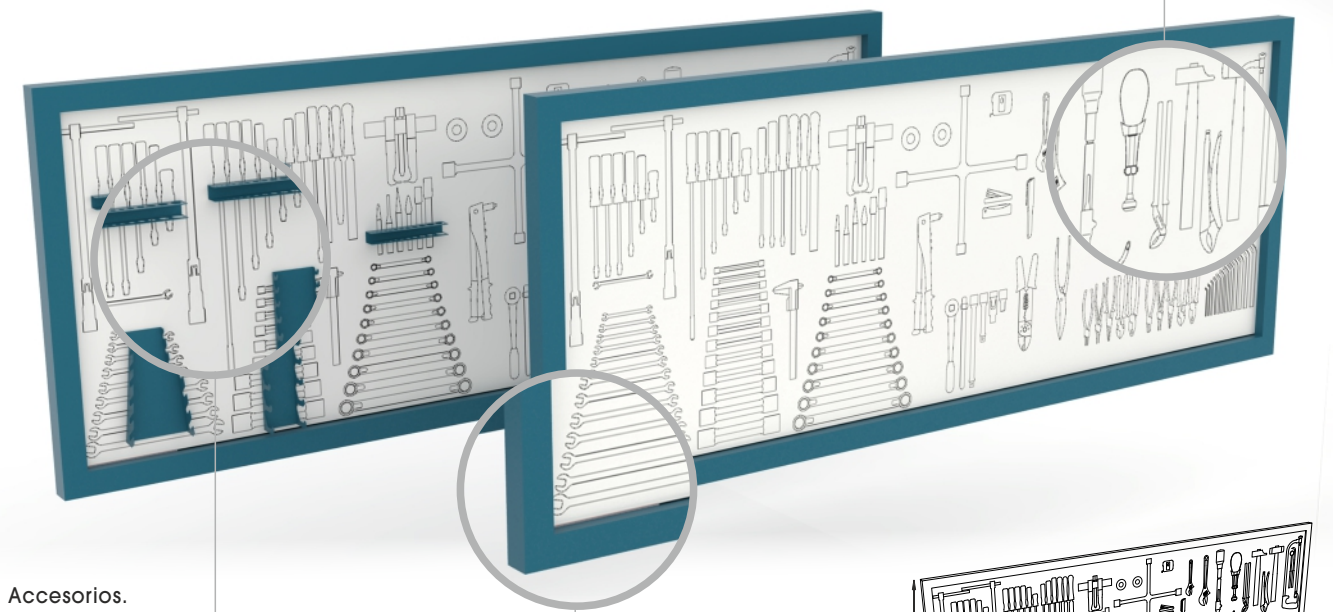

Accesorios.  
Accessoires.  
Accessories.

Estructura metálica.  
Chassis métallique.  
Metallic frame.

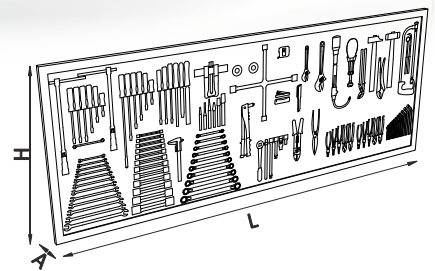

		L x A x H
109 10 1	10,50 Kg	1070x25x800
109 13 1	13,5 Kg	1370x25x800
109 15 1	15,50 Kg	1570x25x800
109 18 1	17 Kg	1870x25x800
109 20 1	19 Kg	2070x25x800

**e** 1 mm estructura chasis / frame

ACCESORIOS ACCESSOIRES / ACCESSORIES

SERIE 110



 Ver información (PAG. 282).  
Voir information (PAG. 282).  
See information (PAG. 282).



No apto para pladur sin taco especial.  
Ne convient pas pour mur en plâtre sans une cheville spéciale.  
Not suitable for plaster wall without a special wedge.

SERIE 109 STANDARD

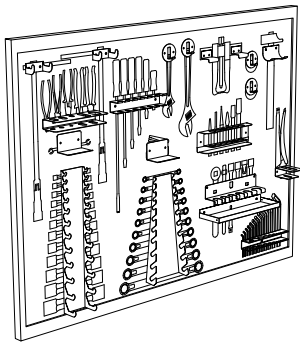

		L x A x H
109 10 1	10,50 Kg	1070 x 25 x 800

accesorios / accessoires / accessories	
1x	110 0 01/110 0 02/110 0 04/110 0 05/110 0 06 110 0 07/110 0 08/110 0 09/110 0 10/110 0 11
2x	110 0 15/110 0 16/110 0 17
4x	110 0 21
<b>68u</b>	total herramientas/ total outils / total tools

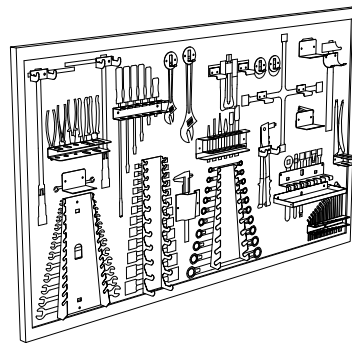

		L x A x H
109 13 1	13,5 Kg	1370 x 25 x 800

accesorios / accessoires / accessories	
1x	110 0 01/110 0 02/110 0 04/110 0 06/110 0 07/ 110 0 08/110 0 09/110 0 10/110 0 11/110 0 14
3x	110 0 15/110 0 15/110 0 16
4x	110 0 17/110 0 21
<b>85u</b>	total herramientas/ total outils / total tools

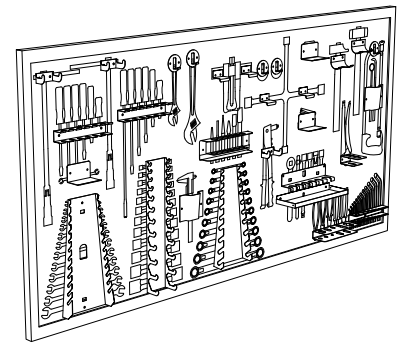

		L x A x H
109 15 1	15,5 Kg	1570 x 25 x 800

accesorios / accessoires / accessories	
1x	110 0 02/110 0 04/110 0 06/110 0 07/ 110 0 09/110 0 10/110 0 11/110 0 14
2x	110 0 01/110 0 08/110 0 18
3x	110 0 05/110 0 16
4x	110 0 15/110 0 17
6x	110 0 21
<b>94u</b>	total herramientas/ total outils / total tools

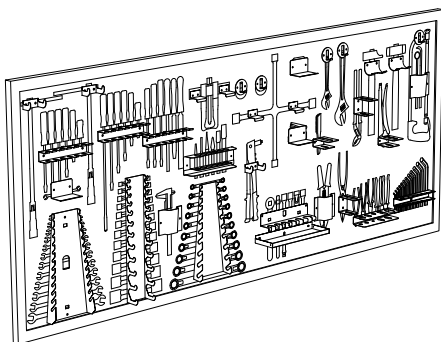

		L x A x H
109 18 1	17 Kg	1870 x 25 x 800

accesorios / accessoires / accessories	
1x	110 0 02/110 0 04/110 0 06/110 0 07/110 0 09/ 110 0 10/110 0 11/110 0 13/110 0 14
2x	110 0 05/110 0 08/110 0 18
3x	110 0 01/110 0 15/110 0 16
4x	110 0 17
7x	110 0 21
<b>104u</b>	total herramientas/ total outils / total tools

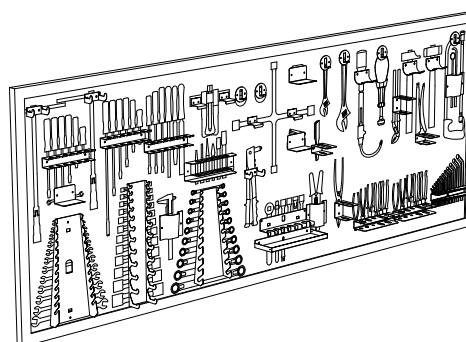

		L x A x H
109 20 1	19 Kg	2070 x 25 x 800

accesorios / accessoires / accessories	
1x	110 0 02/110 0 06/110 0 07/110 0 09/ 110 0 10/110 0 11/110 0 13/110 0 14
2x	110 0 04/110 0 18
3x	110 0 01/110 0 05/110 0 08/110 0 15/110 0 16
4x	110 0 17
7x	110 0 21
<b>109u</b>	total herramientas/ total outils / total tools

SERIE 109 20

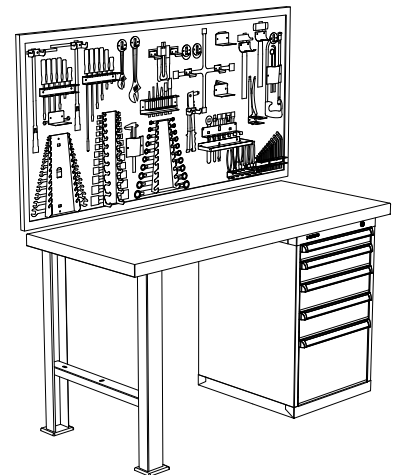

SERIE 136 20

Solución Solution Solution



**SERIE 145** ref. 145 10/13/15/18/20

PANELES PANNEAUX PANELS

Paneles perforados.  
Panneaux pèrforés.  
Perforated panels.

Panel perforado.  
Panneau perforé.  
Perforated panels.

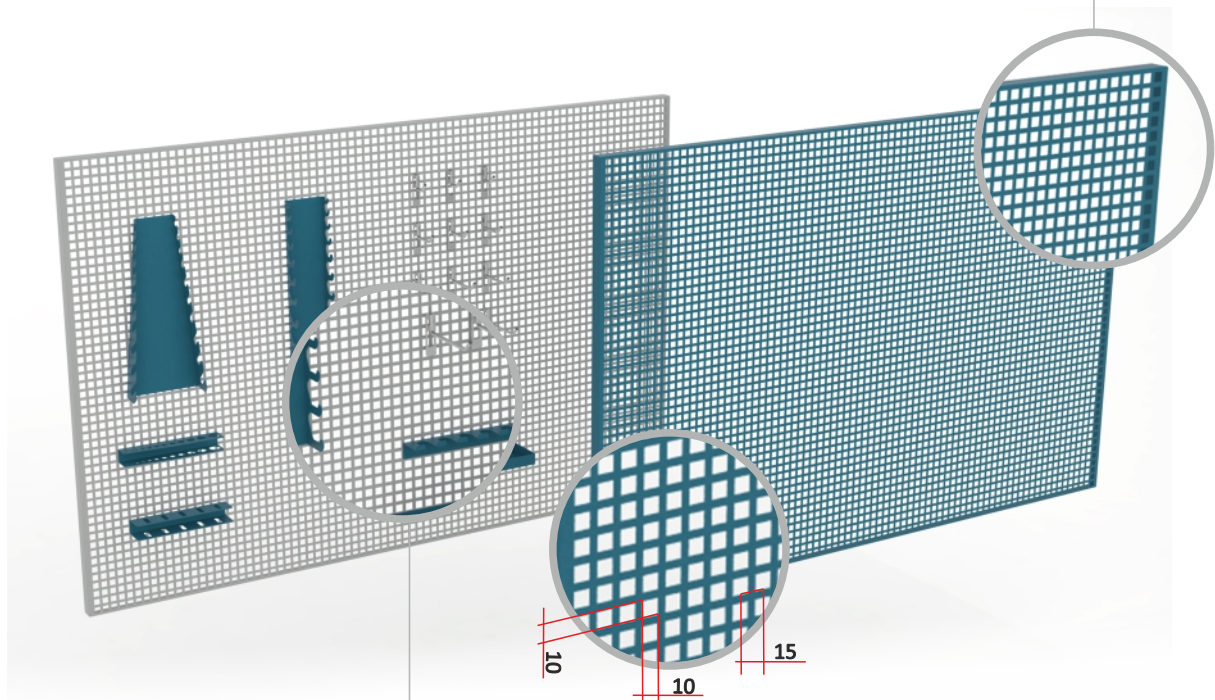

Accesorios.  
Accessoires.  
Accessories.

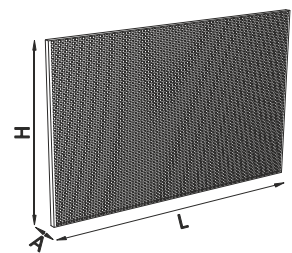

ACCESORIOS ACCESSOIRES / ACCESSORIES

SERIE 141



Ver información (PAG. 283).  
Voir information (PAG. 283).  
See information (PAG. 283).

		L x A x H (mm)
145 10	9,5 Kg	1000x25x800
145 13	12 Kg	1300x25x800
145 15	13 Kg	1500x25x800
145 18	17 Kg	1800x25x800
145 20	19 Kg	2000x25x800

**e** 1,2 mm



No apto para pladur sin taco especial.  
Ne convient pas pour mur en plâtre sans une cheville spéciale.  
Not suitable for plaster wall without a special wedge.



Los paneles se sirven sin soportes.  
Les panneaux sont fournis sans supports.  
Panels are supplied without supports.

SERIE 145 STANDARD

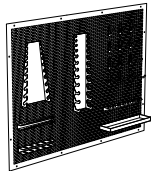
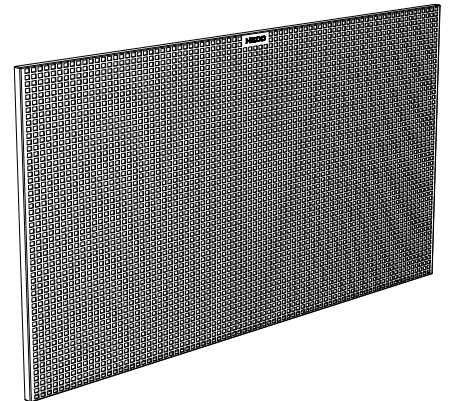
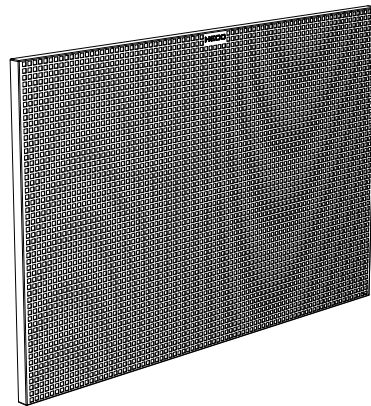
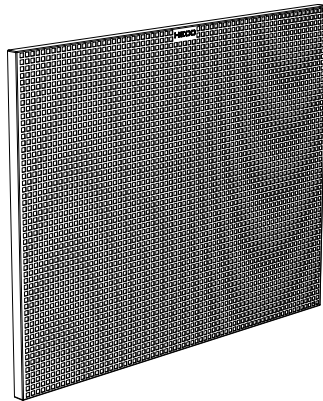

145 10 1  
Solo soportes  
Seul supports  
Only supports

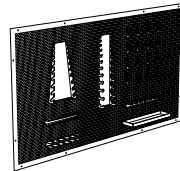

145 13 1  
Solo soportes  
Seul supports  
Only supports

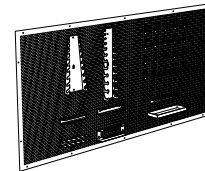

145 15 1  
Solo soportes  
Seul supports  
Only supports

		LxAxH
145 10	9,5 Kg	1000 x 25 x 800

		LxAxH
145 13	12 Kg	1300 x 25 x 800

		LxAxH
145 15	13 Kg	1500 x 25 x 800

accesorios / accessoires / accessories		
145 10 1	soportes / supports / supports	2,4 Kg
1x	141 0 10/141 0 14/141 0 17/ 141 0 18/141 0 19	
3x	141 0 01/141 0 02/141 0 03/141 0 04	
<b>17u</b> total soportes/total supports/total supports		

accesorios / accessoires / accessories		
145 13 1	soportes / supports / supports	2,7 Kg
1x	141 0 10/141 0 14/141 0 17/ 141 0 18/141 0 19	
4x	141 0 01/141 0 02/141 0 03/141 0 04	
<b>21u</b> total soportes/total supports/total supports		

accesorios / accessoires / accessories		
145 15 1	soportes / supports / supports	3,2 Kg
1x	141 0 10/141 0 12/141 0 14/141 0 17/ 141 0 18/141 0 19/141 0 23	
5x	141 0 01/141 0 02/141 0 03/141 0 04	
<b>27u</b> total soportes/total supports/total supports		

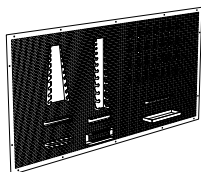
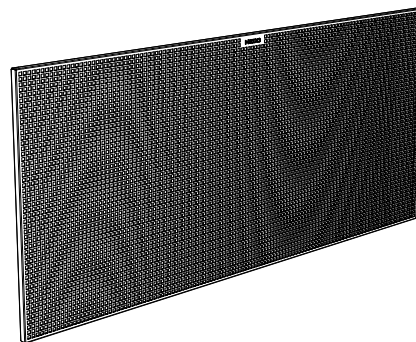
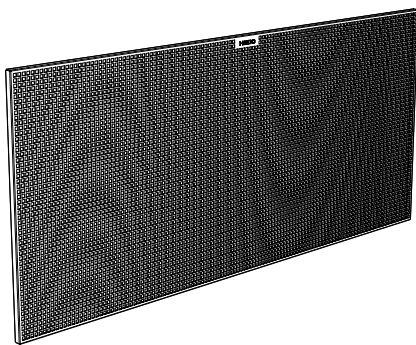

145 18 1  
Solo soportes  
Seul supports  
Only supports

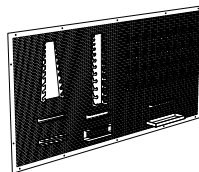

145 20 1  
Solo soportes  
Seul supports  
Only supports

		LxAxH
145 18	17 Kg	1800 x 25 x 800

		LxAxH
145 20	19 Kg	2000 x 25 x 800

accesorios / accessoires / accessories		
145 18 1	soportes / supports / supports	3,4 Kg
1x	141 0 10/141 0 12/141 0 14/141 0 17/ 141 0 18/141 0 19/141 0 23	
7x	141 0 01/141 0 02/141 0 03/141 0 04	
<b>35u</b> total soportes/total supports/total supports		

accesorios / accessoires / accessories		
145 20 1	soportes / supports / supports	3,6 Kg
1x	141 0 10/141 0 12/141 0 14/141 0 17/ 141 0 18/141 0 19/141 0 23	
9x	141 0 01/141 0 02/141 0 03/141 0 04	
<b>43u</b> total soportes/total supports/total supports		

SERIE 145 20



SERIE 136 20 C2

Solución Solution Solution



**SERIE 145 C** ref. 145 10/13/15/18/20 C

PANELES PANNEAUX PANELS

Paneles perforados con espacio para cubetas.  
Panneaux pèrforés avec espace pour bacs à bec.  
Perforated panels with space for receptacles.

Panel perforado.  
Panneau perforé.  
Perforated panels.

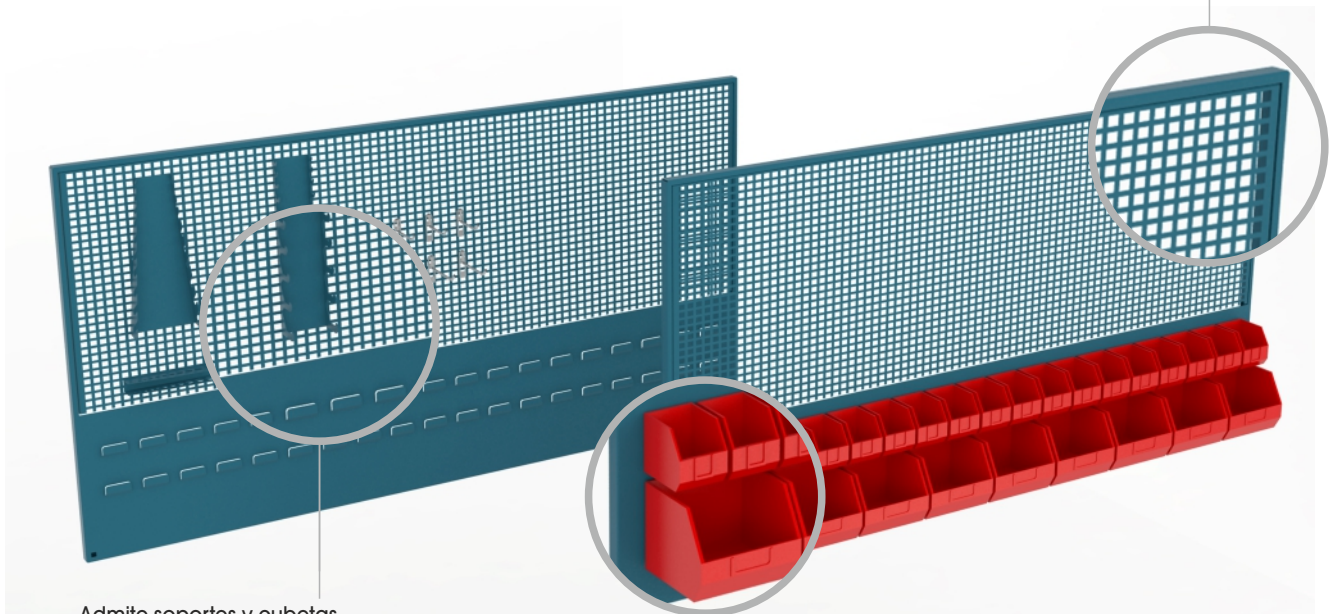

Admite soportes y cubetas.  
Admets supports et boîtes.  
Admit supports and trays.

Fijación de soportes.  
Fixation de supports.  
Supports fixation.

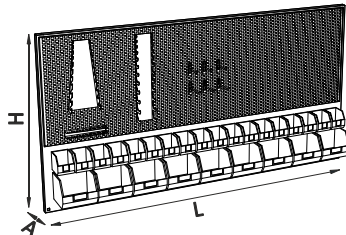
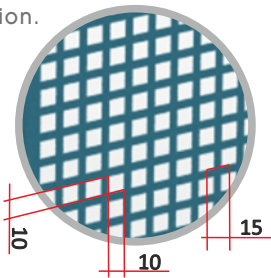

		L x A x H (mm)
145 10 C	9,5 Kg	1000x25x800
145 13 C	12 Kg	1300x25x800
145 15 C	13 Kg	1500x25x800
145 18 C	17 Kg	1800x25x800
145 20 C	19 Kg	2000x25x800

**e** 1,2 mm



No apto para pladur sin taco especial.  
Ne convient pas pour mur en plâtre sans une cheville spéciale.  
Not suitable for plaster wall without a special wedge.



Los paneles se sirven sin soportes y sin cubetas.  
Les panneaux sont fournis sans supports et sans bacs à bacs.  
Panels are supplied without supports and trays.

**SOPORTES SUPPORTS / SUPPORTS**

**SERIE 141**



Ver información (PAG. 283).  
Voir information (PAG. 283).  
View information (PAG. 283).

**CUBETAS BACS À BEC / TRAYS**

**SERIE V-BULL**

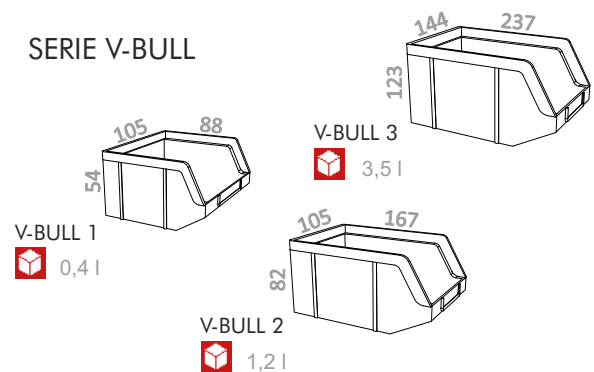

V-BULL 1  
 0,4 l

V-BULL 2  
 1,2 l

V-BULL 3  
 3,5 l



Ver información (PAG. 302).  
Voir information (PAG. 302).  
View information (PAG. 302).

SERIE 145 C STANDARD

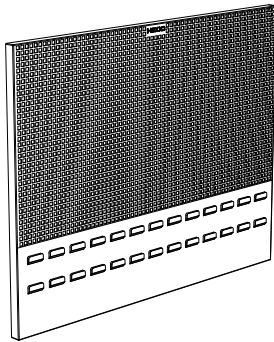

		L x A x H
145 10 C	9,5 Kg	1000 x 25 x 800

accesorios / accessoires / accessories		
<b>145 10 1</b>	soportes / supports / supports	2,4 Kg
1x	141 0 10/141 0 14/141 0 17/ 141 0 18/141 0 19	
3x	141 0 01/141 0 02/141 0 03/141 0 04	
<b>17u</b>	total soportes/total supports/total supports	

Ver (PAG.105). Voir (PAG. 105). View (PAG. 105).

capacidad / capacité / capacity		
<b>V-BULL 1</b>	18 cubetas / 18 bacs à bec / 18 trays	
<b>V-BULL 2</b>	18 cubetas / 18 bacs à bec / 18 trays	
<b>V-BULL 3</b>	12 cubetas / 12 bacs à bec / 12 trays solo fila inferior / seulement ligne inférieure / only botton line	

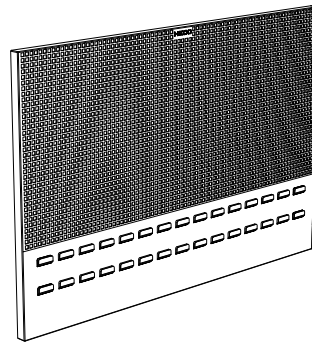

		L x A x H
145 13 C	12 Kg	1300 x 25 x 800

accesorios / accessoires / accessories		
<b>145 13 1</b>	soportes / supports / supports	2,7 Kg
1x	141 0 10/141 0 14/141 0 17/ 141 0 18/141 0 19	
4x	141 0 01/141 0 02/141 0 03/141 0 04	
<b>21u</b>	total soportes/total supports/total supports	

Ver (PAG.105). Voir (PAG. 105). View (PAG. 105).

capacidad / capacité / capacity		
<b>V-BULL 1</b>	24 cubetas / 24 bacs à bec / 24 trays	
<b>V-BULL 2</b>	24 cubetas / 24 bacs à bec / 24 trays	
<b>V-BULL 3</b>	18 cubetas / 18 bacs à bec / 18 trays solo fila inferior / seulement ligne inférieure / only botton line	

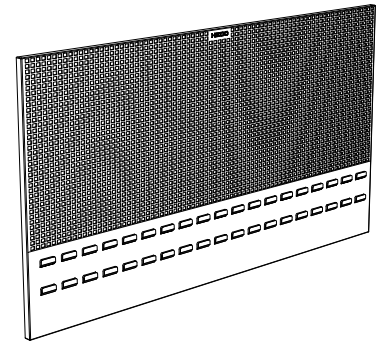

		L x A x H
145 15 C	13 Kg	1500 x 25 x 800

accesorios / accessoires / accessories		
<b>145 15 1</b>	soportes / supports / supports	3,2 Kg
1x	141 0 10/141 0 12/141 0 14/141 0 17/ 141 0 18/141 0 19/141 0 23	
5x	141 0 01/141 0 02/141 0 03/141 0 04	
<b>27u</b>	total soportes/total supports/total supports	

Ver (PAG.105). Voir (PAG. 105). View (PAG. 105).

capacidad / capacité / capacity		
<b>V-BULL 1</b>	28 cubetas / 28 bacs à bec / 28 trays	
<b>V-BULL 2</b>	28 cubetas / 28 bacs à bec / 28 trays	
<b>V-BULL 3</b>	20 cubetas / 20 bacs à bec / 20 trays solo fila inferior / seulement ligne inférieure / only botton line	

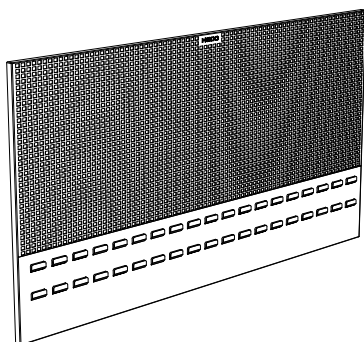

		L x A x H
145 18 C	17 Kg	1800 x 25 x 800

accesorios / accessoires / accessories		
<b>145 18 1</b>	soportes / supports / supports	3,4 Kg
1x	141 0 10/141 0 12/141 0 14/141 0 17/ 141 0 18/141 0 19/141 0 23	
7x	141 0 01/141 0 02/141 0 03/141 0 04	
<b>35u</b>	total soportes/total supports/total supports	

Ver (PAG.105). Voir (PAG. 105). View (PAG. 105).

capacidad / capacité / capacity		
<b>V-BULL 1</b>	32 cubetas / 32 bacs à bec / 32 trays	
<b>V-BULL 2</b>	32 cubetas / 32 bacs à bec / 32 trays	
<b>V-BULL 3</b>	24 cubetas / 24 bacs à bec / 24 trays solo fila inferior / seulement ligne inférieure / only botton line	

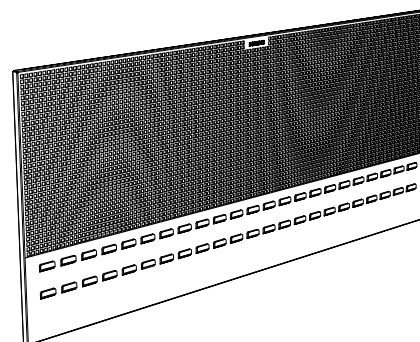

		L x A x H
145 20 C	19 Kg	2000 x 25 x 800

accesorios / accessoires / accessories		
<b>145 20 1</b>	soportes / supports / supports	3,6 Kg
1x	141 0 10/141 0 12/141 0 14/141 0 17/ 141 0 18/141 0 19/141 0 23	
9x	141 0 01/141 0 02/141 0 03/141 0 04	
<b>43u</b>	total soportes/total supports/total supports	

Ver (PAG.105). Voir (PAG. 105). View (PAG. 105).

capacidad / capacité / capacity		
<b>V-BULL 1</b>	36 cubetas / 36 bacs à bec / 36 trays	
<b>V-BULL 2</b>	36 cubetas / 36 bacs à bec / 36 trays	
<b>V-BULL 3</b>	26 cubetas / 26 bacs à bec / 26 trays solo fila inferior / seulement ligne inférieure / only botton line	

SERIE 145 13 C  
SERIE V-BULL  
SERIE CTP

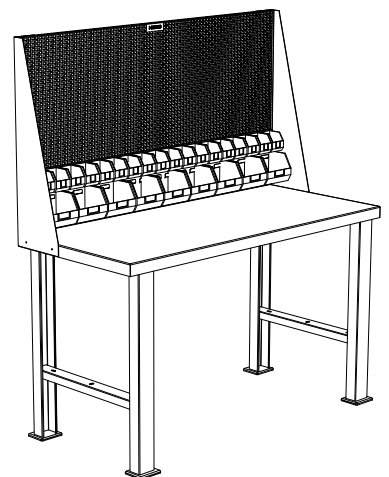

SERIE 112 15

Solución Solution Solution





SERIE 145 CTP STANDARD

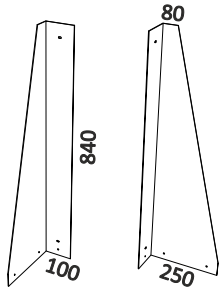

LxAxH		
145 CTP	10 Kg	250 x 100 x 840

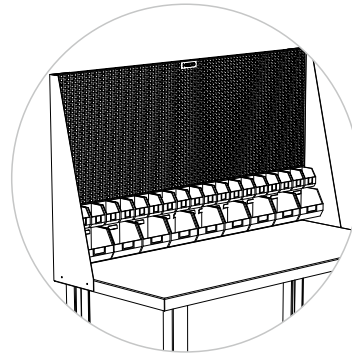

SERIE 145 13 C  
SERIE V-BULL  
SERIE CTP  
SERIE 112 15

Solución Solution Solution

SERIE 112 SL STANDARD

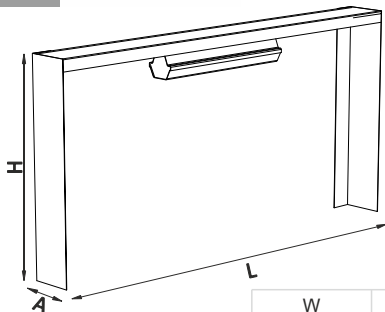

	W	LxAxH
112 10 SL	1x18	1000 x 200 x 1200
112 13 SL	1x18	1300 x 200 x 1200
112 15 SL	1x36	1500 x 200 x 1200
112 18 SL	1x58	1800 x 200 x 1200
112 20 SL	1x58	2000 x 200 x 1200

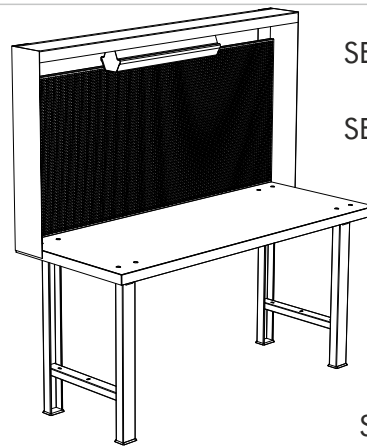

SERIE 112 20 SL  
SERIE 145 20

SERIE 112 20 C

Solución Solution Solution

SERIE 110 SOPORTES SUPPORTS SUPPORTS

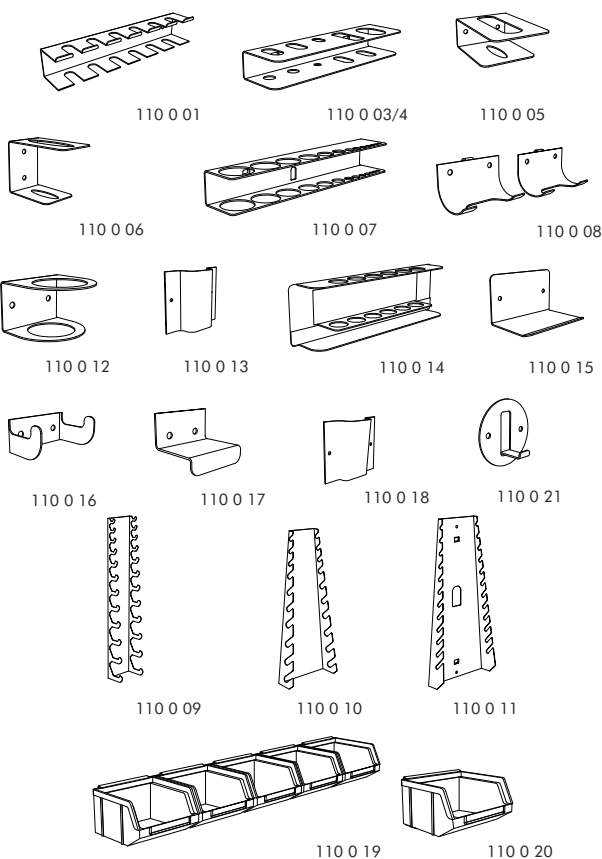

SERIE 141 SOPORTES SUPPORTS SUPPORTS

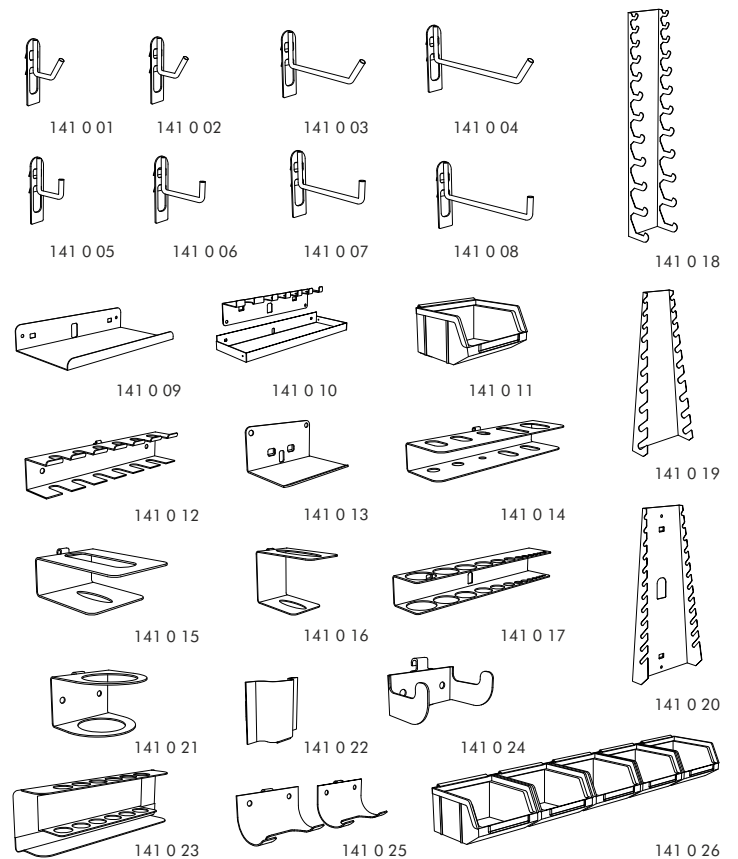

SERIE 141

ref. 141 0 / 141 1/ 141 2/ 141 3/ 141 4

Panel perforado en cuadrado.  
Panneau perforé carré.  
Square perforated panel.

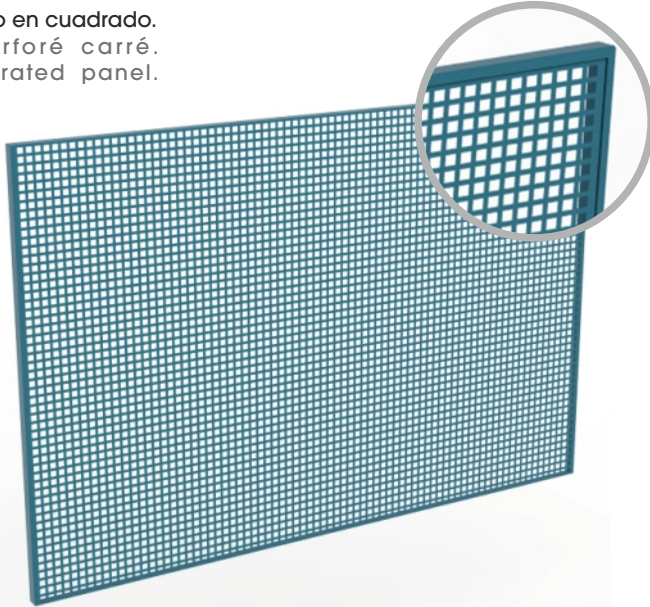

BRICO

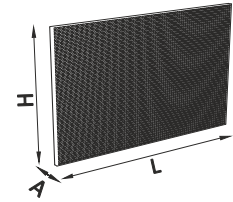

		L x A x H (mm)
141 0	4,96 Kg	1000x13x500

**e** 1,2 mm



Fijación con tornillos.  
Fixation avec vis.  
Fixing with screws.



El panel se sirve sin soportes.  
Panneau livré sans supports.  
Panel is supplied without supports.

SERIE 141

STANDARD

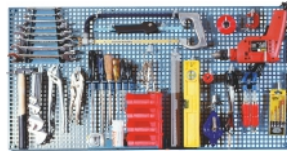
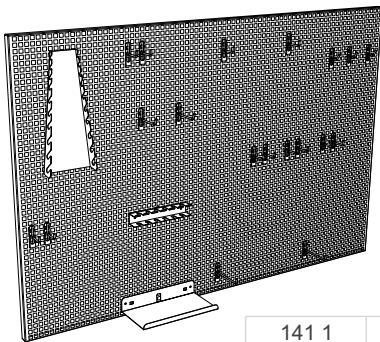

		L x A x H
141 1	7,86 Kg	1000 x 13 x 500

BRICO-HOGAR BRICO-MAISON / BRICO-HOME

componentes / composants / components		
1x	141 0 09 / 141 0 12 / 141 0 19	
2x	141 0 03 / 141 0 08	
3x	141 0 01	
15x	141 0 06	4x V-BULL 1

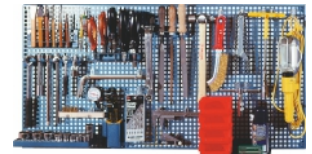
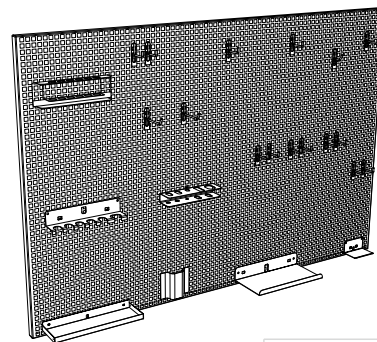

		L x A x H
141 2	7,86 Kg	1000 x 13 x 500

BRICO-MECANICO BRICO-MÉCANIQUE / BRICO-MECHANICAL

componentes / composants / components		
1x	141 0 01 / 141 0 04 / 141 0 08 / 141 0 09 / 141 0 10 / 141 0 13 / 141 0 14 / 141 0 22 / 141 0 23	
19x	141 0 06	4x V-BULL 1

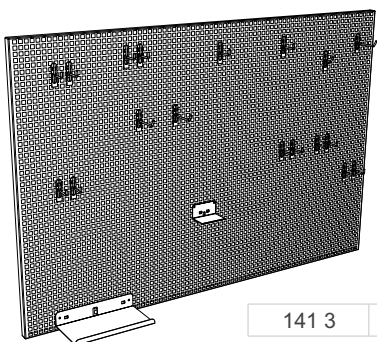

		L x A x H
141 3	7,86 Kg	1000 x 13 x 500

BRICO-CARPINTERO BRICO-MENUISIER / BRICO-CARPENTER

componentes / composants / components		
1x	141 0 09 / 141 0 13	
3x	141 0 01	
6x	141 0 08	
17x	141 0 06	4x V-BULL 1

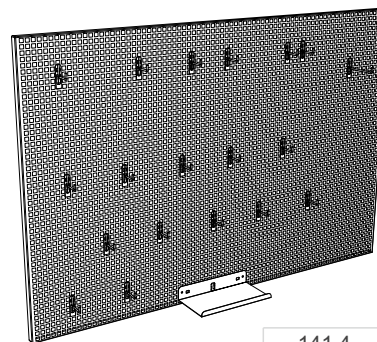

		L x A x H
141 4	7,86 Kg	1000 x 13 x 500

BRICO-JARDINERO BRICO-JARDINIER / BRICO-GARDENER

componentes / composants / components		
1x	141 0 08 / 141 0 09	
22x	141 0 06	4x V-BULL 1



**SERIE 144** ref. 144 0 / 144 1 / 144 2

BRICO

Panel perforado en redondo.  
Panneau perforé rond.  
Round perforated panel.

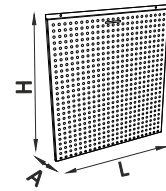

144 0	2 Kg	L x A x H (mm) 480x10x530
-------	------	------------------------------

**e** 0,7 mm

**i** Fijación con tornillos.  
Fixation avec vis.  
Fixing with screws.

**SERIE 144** STANDARD

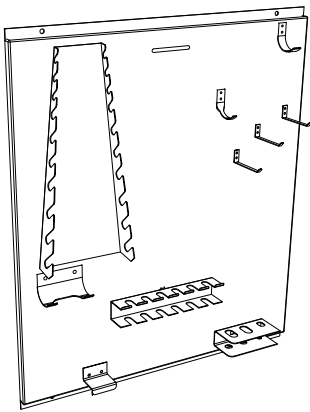

144 1	7,5 Kg		L x A x H 480 x 10 x 530
-------	--------	--	-----------------------------

**i** Sin serigrafiar. Accesorios remachados.  
Sans sérigraphie. Accessoires rivetés.  
Without screen printing. Riveted accessories.

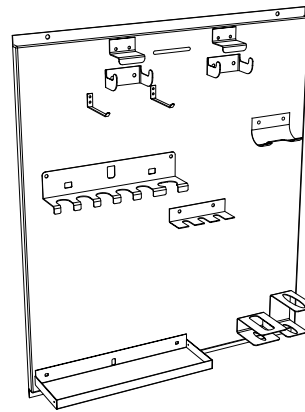

144 2	7,5 Kg		L x A x H 480 x 10 x 530
-------	--------	--	-----------------------------

**i** Sin serigrafiar. Accesorios remachados.  
Sans sérigraphie. Accessoires rivetés.  
Without screen printing. Riveted accessories.

**SERIE 144** ACCESORIOS ACCESSOIRES / ACCESSORIES

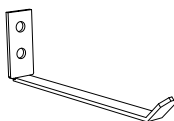

144 0 01	5		L x A x H 14 x 58 x 35
----------	---	--	---------------------------

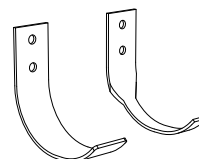

144 0 02	2		L x A x H 30 x 55 x 70
----------	---	--	---------------------------

**SERIE 110** ref. 110 C / 110 4 / 110 1

ARMARIOS CON PERSIANA ARMOIRES AVEC RIDEAU / SHUTTER CABINETS

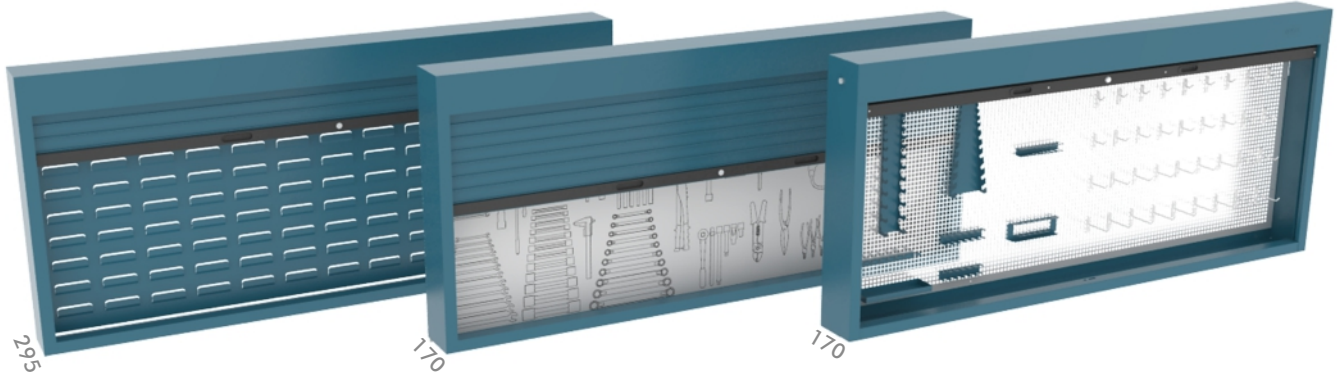

**SERIE 110 C**

**i** Con porta cubetas.  
Pour bacs à bec.  
With tray supports.

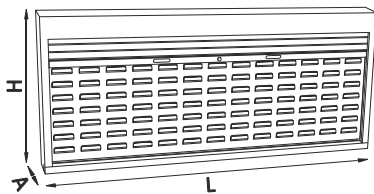

		L x A x H (mm)
110 10 C	31 Kg	1000x295x900
110 13 C	38,5 Kg	1300x295x900
110 15 C	43 Kg	1500x295x900
110 18 C	50 Kg	1800x295x900
110 20 C	53 Kg	2000x295x900

**e** 1 mm

**i** Profundidad útil 245 mm.  
Profondeur utile 245 mm.  
Useful depth 245 mm.

**SERIE 110 1**

**i** Con panel serigrafiado.  
Avec panneau serigraphié.  
With screen printed panel.

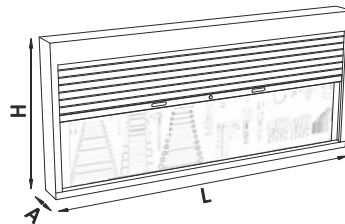

		L x A x H (mm)
110 10 1	32 Kg	1000x170x900
110 13 1	38 Kg	1300x170x900
110 15 1	41 Kg	1500x170x900
110 18 1	48 Kg	1800x170x900
110 20 1	52 Kg	2000x170x900

**e** 1 mm

**i** Profundidad útil 120 mm.  
Profondeur utile 120 mm.  
Useful depth 120 mm.

**SERIE 110 4**

**i** Con panel perforado.  
Avec panneau perforé.  
With perforated panel.

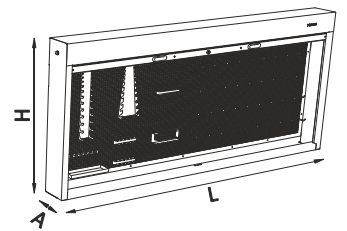

		L x A x H (mm)
110 10 4	36,5 Kg	1000x170x900
110 13 4	51 Kg	1300x170x900
110 15 4	64,8 Kg	1500x170x900
110 18 4	66,5 Kg	1800x170x900
110 20 4	72 Kg	2000x170x900

**e** 1 mm

**i** Profundidad útil 120 mm.  
Profondeur utile 120 mm.  
Useful depth 120 mm.

**SOPORTES SUPPORTS / SUPPORTS**

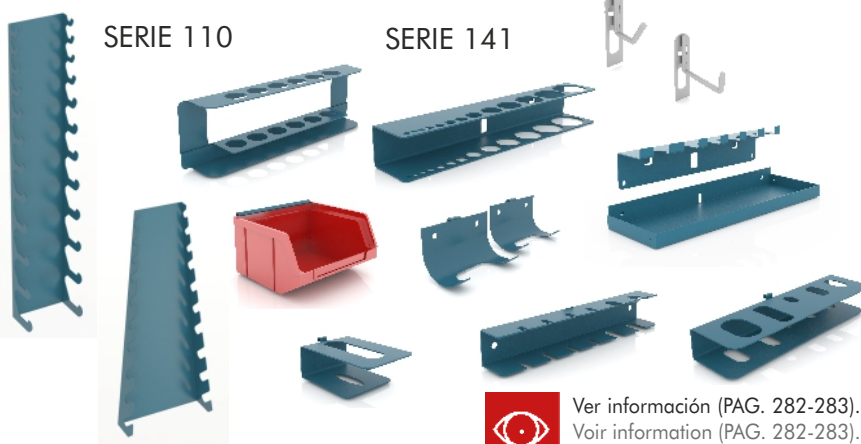

**SERIE 110**

**SERIE 141**

**e** Ver información (PAG. 282-283).  
Voir information (PAG. 282-283).  
See information (PAG. 282-283).

**CUBETAS BACS À BEC / TRAYS**

**SERIE V-BULL**

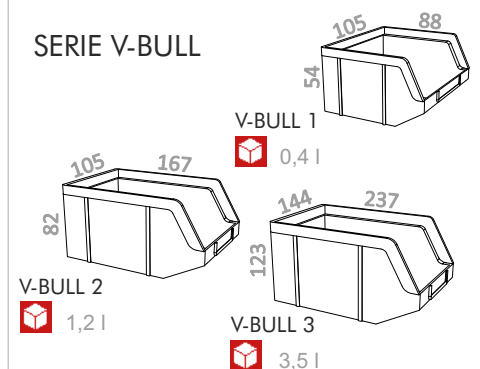

**e** Ver información (PAG. 302).  
Voir information (PAG. 302).  
See information (PAG. 302).



SERIE 110 1 STANDARD

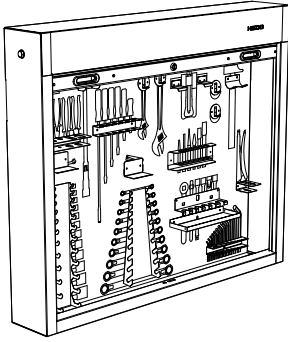

		LxAxH
110 10 1	32 Kg	1000 x 170 x 900
accesorios / accessoires / accessories		
1x	110 0 01/110 0 02/110 0 04/110 0 05/110 0 06 110 0 07/110 0 08/110 0 09/110 0 10/110 0 11	
2x	110 0 15/110 0 16/110 0 17	
4x	110 0 21	
<b>68u</b>	total herramientas/ total outils / total tools	

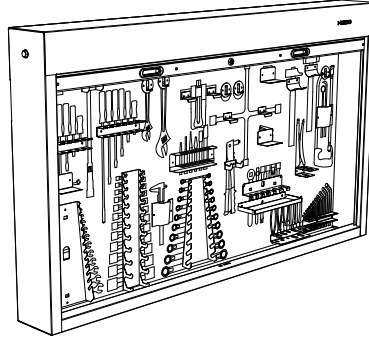

		LxAxH
110 13 1	38 Kg	1300 x 170 x 900
accesorios / accessoires / accessories		
1x	110 0 01/110 0 02/110 0 04/110 0 06/110 0 07/ 110 0 08/110 0 09/110 0 10/110 0 11/110 0 14	
3x	110 0 15/110 0 15/110 0 16	
4x	110 0 17/110 0 21	
<b>85u</b>	total herramientas/ total outils / total tools	

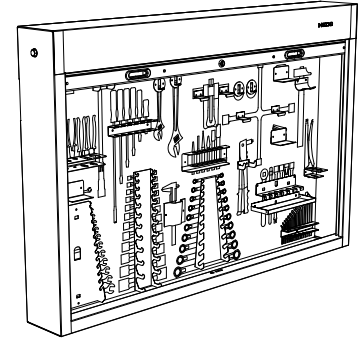

		LxAxH
110 15 1	41 Kg	1500 x 170 x 900
accesorios / accessoires / accessories		
1x	110 0 02/110 0 04/110 0 06/110 0 07/ 110 0 09/110 0 10/110 0 11/110 0 14	
2x	110 0 01/110 0 08/110 0 18	
3x	110 0 05/110 0 16	
4x	110 0 15/110 0 17	
6x	110 0 21	
<b>94u</b>	total herramientas/ total outils / total tools	

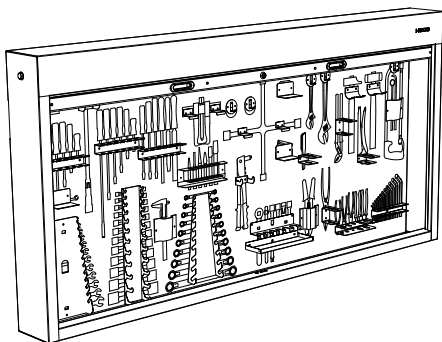

		LxAxH
110 18 1	48 Kg	1800 x 170 x 900
accesorios / accessoires / accessories		
1x	110 0 02/110 0 04/110 0 06/110 0 07/110 0 09/ 110 0 10/110 0 11/110 0 13/110 0 14	
2x	110 0 05/110 0 08/110 0 18	
3x	110 0 01/110 0 15/110 0 16	
4x	110 0 17	
7x	110 0 21	
<b>104u</b>	total herramientas/ total outils / total tools	

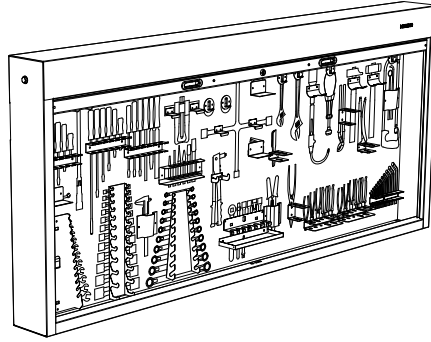

		LxAxH
110 20 1	52 Kg	2000 x 170 x 900
accesorios / accessoires / accessories		
1x	110 0 02/110 0 06/110 0 07/110 0 09/ 110 0 10/110 0 11/110 0 13/110 0 14	
2x	110 0 04/110 0 18	
3x	110 0 01/110 0 05/110 0 08/110 0 15/110 0 16	
4x	110 0 17	
7x	110 0 21	
<b>109u</b>	total herramientas/ total outils / total tools	

SERIE 110 18 1

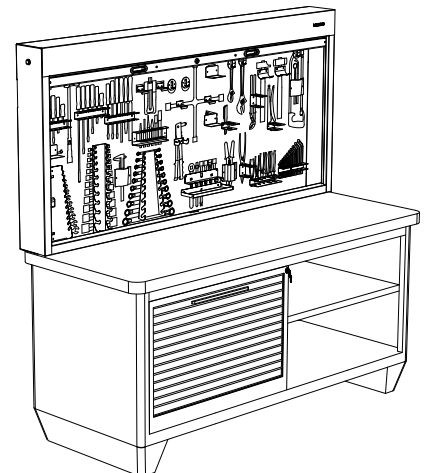

SERIE 118 18

Solución Solution Solution

SERIE 110 4 STANDARD

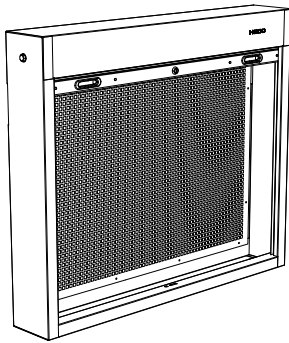

		L x A x H
110 10 4	36,5 Kg	1000 x 170 x 900

accesorios / accessoires / accessories		
145 10 1	soportes / supports / supports	2,4 Kg
1x	141 0 10/141 0 14/141 0 17/ 141 0 18/141 0 19	
3x	141 0 01/141 0 02/141 0 03/141 0 04	
<b>17u</b> total soportes/total supports/total supports		

Ver (PAG.105). Voir (PAG. 105). See (PAG. 105).

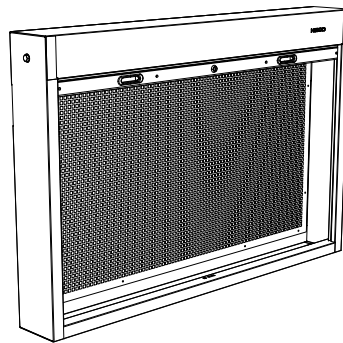

		L x A x H
110 13 4	51 Kg	1300 x 170 x 900

accesorios / accessoires / accessories		
145 13 1	soportes / supports / supports	2,7 Kg
1x	141 0 10/141 0 14/141 0 17/ 141 0 18/141 0 19	
4x	141 0 01/141 0 02/141 0 03/141 0 04	
<b>21u</b> total soportes/total supports/total supports		

Ver (PAG.105). Voir (PAG. 105). See (PAG. 105).

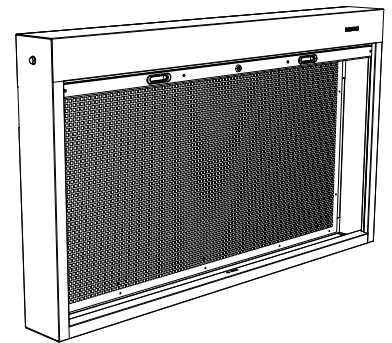

		L x A x H
110 15 4	64,8 Kg	1500 x 170 x 900

accesorios / accessoires / accessories		
145 15 1	soportes / supports / supports	3,2 Kg
1x	141 0 10/141 0 12/141 0 14/141 0 17/ 141 0 18/141 0 19/141 0 23	
5x	141 0 01/141 0 02/141 0 03/141 0 04	
<b>27u</b> total soportes/total supports/total supports		

Ver (PAG.105). Voir (PAG. 105). See (PAG. 105).

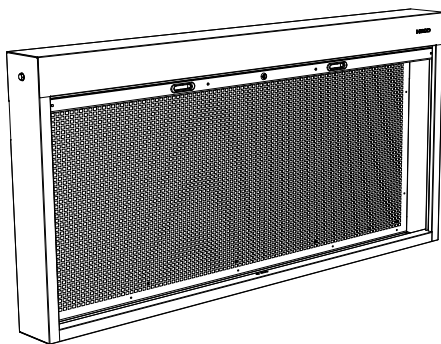

		L x A x H
110 18 4	66,5 Kg	1800 x 170 x 900

accesorios / accessoires / accessories		
145 18 1	soportes / supports / supports	3,4 Kg
1x	141 0 10/141 0 12/141 0 14/141 0 17/ 141 0 18/141 0 19/141 0 23	
7x	141 0 01/141 0 02/141 0 03/141 0 04	
<b>35u</b> total soportes/total supports/total supports		

Ver (PAG.105). Voir (PAG. 105). See (PAG. 105).

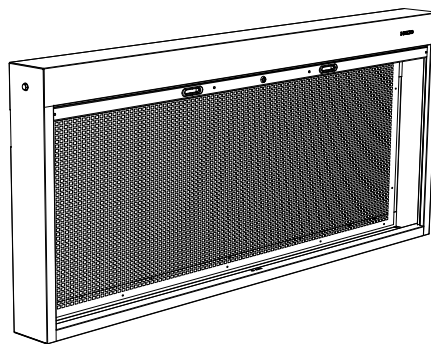

		L x A x H
110 20 4	72 Kg	2000 x 170 x 900

accesorios / accessoires / accessories		
145 20 1	soportes / supports / supports	3,6 Kg
1x	141 0 10/141 0 12/141 0 14/141 0 17/ 141 0 18/141 0 19/141 0 23	
9x	141 0 01/141 0 02/141 0 03/141 0 04	
<b>43u</b> total soportes/total supports/total supports		

Ver (PAG.105). Voir (PAG. 105). See (PAG. 105).

SERIE 110 18

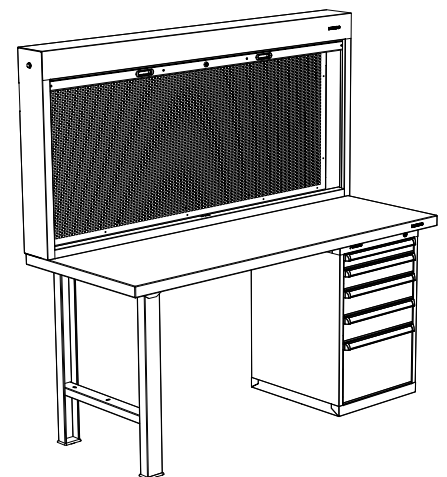

SERIE 136 18

Solución Solution Solution



SERIE 110 C STANDARD

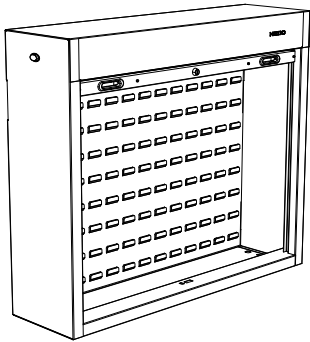

110 10 C	31 Kg	LxAxH 1000 x 295 x 900
----------	-------	---------------------------

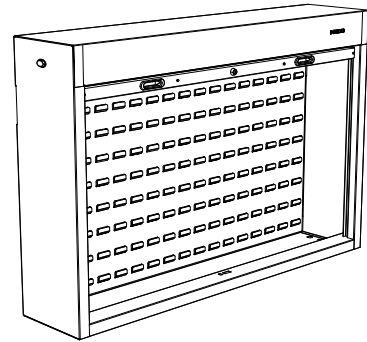

110 13 C	38,5 Kg	LxAxH 1300 x 295 x 900
----------	---------	---------------------------

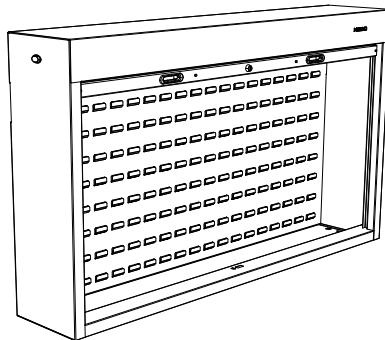

110 15 C	43 Kg	LxAxH 1500 x 295 x 900
----------	-------	---------------------------

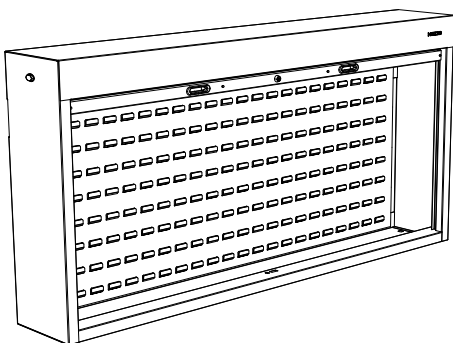

110 18 C	50 Kg	LxAxH 1800 x 295 x 900
----------	-------	---------------------------

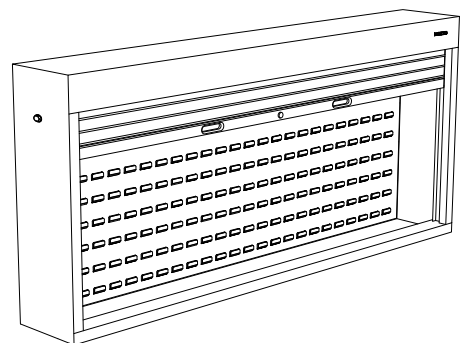

110 20 C	53 Kg	LxAxH 2000 x 295 x 900
----------	-------	---------------------------

SERIE 110 C 1 STANDARD

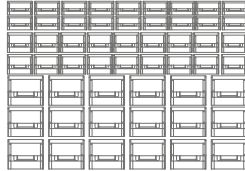
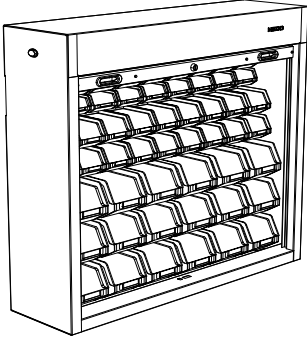

		L x A x H
110 10 C 1	38 Kg	1000 x 295 x 900

componentes / composants / composants	
V-BULL 1	18 cubetas / 18 bacs à bec / 18 trays
V-BULL 2	18 cubetas / 18 bacs à bec / 18 trays
V-BULL 3	18 cubetas / 18 bacs à bec / 18 trays

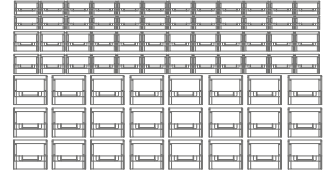
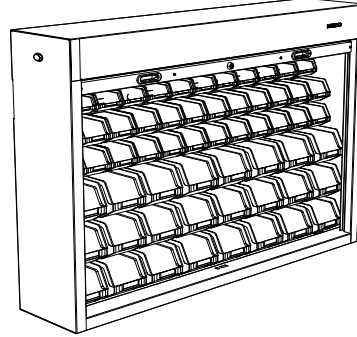

		L x A x H
110 13 C 1	48 Kg	1300 x 295 x 900

componentes / composants / composants	
V-BULL 1	24 cubetas / 24 bacs à bec / 24 trays
V-BULL 2	24 cubetas / 24 bacs à bec / 24 trays
V-BULL 3	24 cubetas / 24 bacs à bec / 24 trays

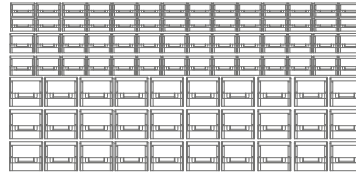
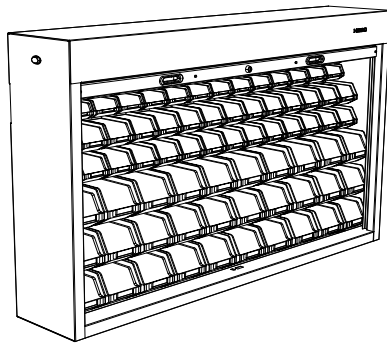

		L x A x H
110 15 C 1	54 Kg	1500 x 295 x 900

componentes / composants / composants	
V-BULL 1	28 cubetas / 28 bacs à bec / 28 trays
V-BULL 2	28 cubetas / 28 bacs à bec / 28 trays
V-BULL 3	30 cubetas / 30 bacs à bec / 30 trays

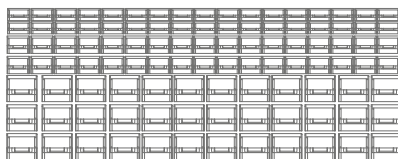
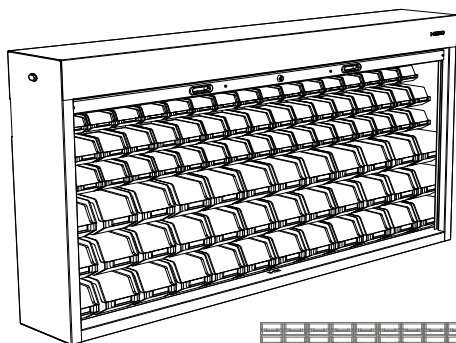

		L x A x H
110 18 C 1	63 Kg	1800 x 295 x 900

componentes / composants / composants	
V-BULL 1	34 cubetas / 34 bacs à bec / 34 trays
V-BULL 2	34 cubetas / 34 bacs à bec / 34 trays
V-BULL 3	36 cubetas / 36 bacs à bec / 36 trays

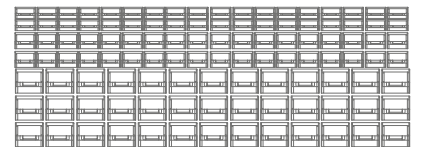
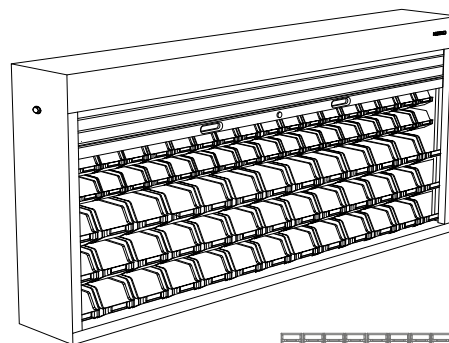

		L x A x H
110 20 C 1	68 Kg	2000 x 295 x 900

componentes / composants / composants	
V-BULL 1	38 cubetas / 38 bacs à bec / 38 trays
V-BULL 2	38 cubetas / 38 bacs à bec / 38 trays
V-BULL 3	39 cubetas / 39 bacs à bec / 39 trays





SERIE 110 C 2 STANDARD

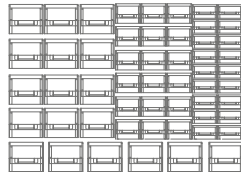
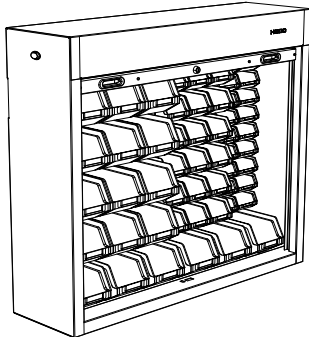

		L x A x H
110 10 C 2	38 Kg	1000 x 295 x 900

componentes / composants / composants		
V-BULL 1	22 cubetas / 22 bacs à bec / 22 trays	
V-BULL 2	18 cubetas / 18 bacs à bec / 18 trays	
V-BULL 3	18 cubetas / 18 bacs à bec / 18 trays	

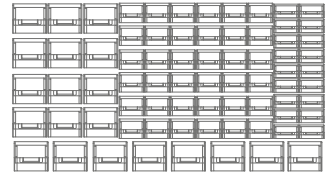
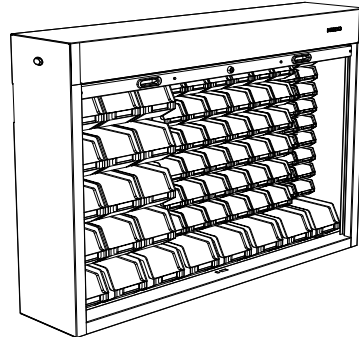

		L x A x H
110 13 C 2	48 Kg	1300 x 295 x 900

componentes / composants / composants		
V-BULL 1	22 cubetas / 22 bacs à bec / 22 trays	
V-BULL 2	36 cubetas / 36 bacs à bec / 36 trays	
V-BULL 3	20 cubetas / 20 bacs à bec / 20 trays	

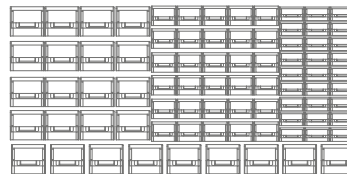
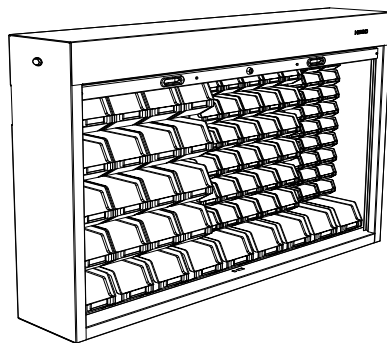

		L x A x H
110 15 C 2	53,5 Kg	1500 x 295 x 900

componentes / composants / composants		
V-BULL 1	33 cubetas / 33 bacs à bec / 33 trays	
V-BULL 2	30 cubetas / 30 bacs à bec / 30 trays	
V-BULL 3	26 cubetas / 26 bacs à bec / 26 trays	

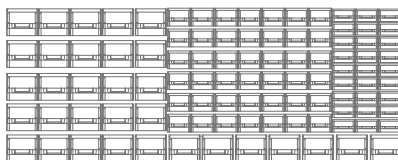
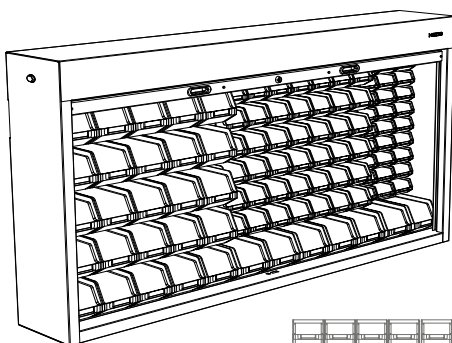

		L x A x H
110 18 C 2	63 Kg	1800 x 295 x 900

componentes / composants / composants		
V-BULL 1	33 cubetas / 33 bacs à bec / 33 trays	
V-BULL 2	42 cubetas / 42 bacs à bec / 42 trays	
V-BULL 3	32 cubetas / 32 bacs à bec / 32 trays	

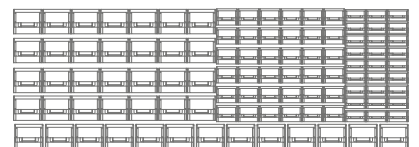
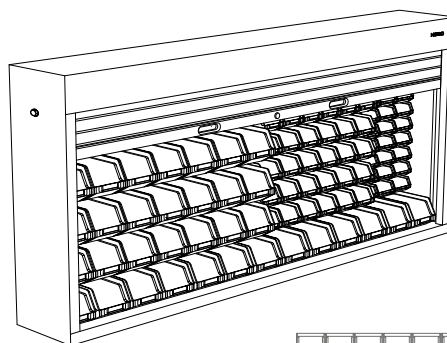

		L x A x H
110 20 C 2	68 Kg	2000 x 295 x 900

componentes / composants / composants		
V-BULL 1	33 cubetas / 33 bacs à bec / 33 trays	
V-BULL 2	36 cubetas / 36 bacs à bec / 36 trays	
V-BULL 3	41 cubetas / 41 bacs à bec / 41 trays	

SERIE 110 PC P

Puertas correderas de metacrilato.  
Portes coulissantes en méthacrylate.  
Sliding doors in methacrylate.

ARMARIOS CON PUERTAS ARMOIRES A PORTES DOORS CABINETS

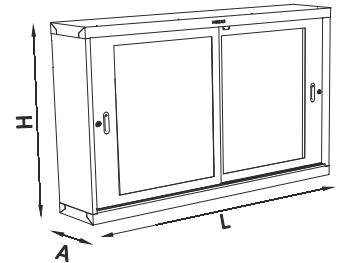
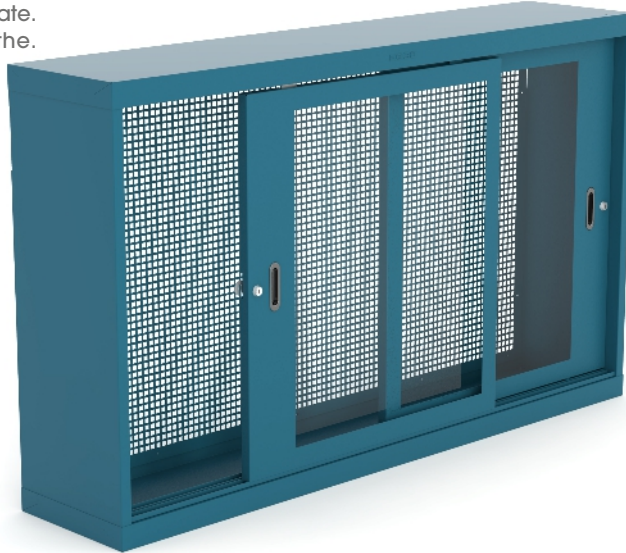

SOPORTES SUPPORTS / SUPPORTS

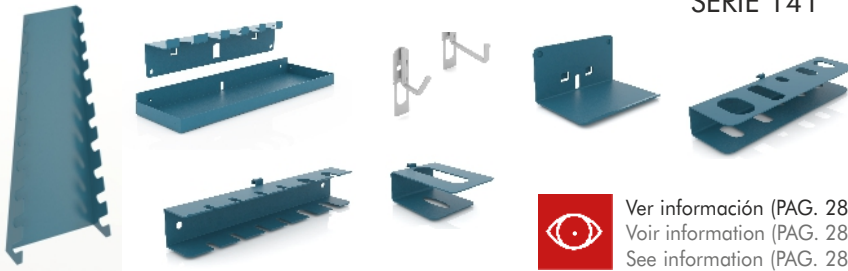

SERIE 141



Ver información (PAG. 283).  
Voir information (PAG. 283).  
See information (PAG. 283).

		L x A x H (mm)
110 10 PC P	36,5 Kg	1000x320x900
110 15 PC P	64,8 Kg	1500x320x900

- e** 1,5 mm panel panneau/panel
- e** 0,6 mm puertas portes/doors
- e** 1/0,8 mm estructura chassis/frame



Con panel perforado.  
Avec panneau perforé.  
With perforated panels.

SERIE 110 10 PC P STANDARD

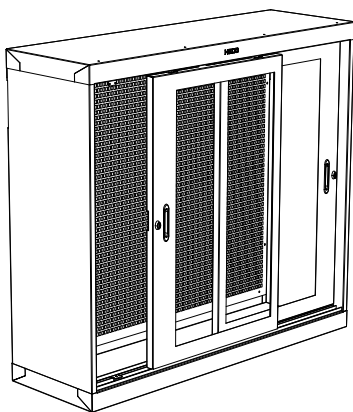

		L x A x H
110 10 PC P	36,5 Kg	1000 x 320 x 900

accesorios / accessoires / accessories		
145 10 1	soportes / supports / supports	2,4 Kg
1x	141 0 10/141 0 14/141 0 17/ 141 0 18/141 0 19	
3x	141 0 01/141 0 02/141 0 03/141 0 04	
<b>17u</b>	total soportes/total supports/total supports	

SERIE 110 15 PC P STANDARD

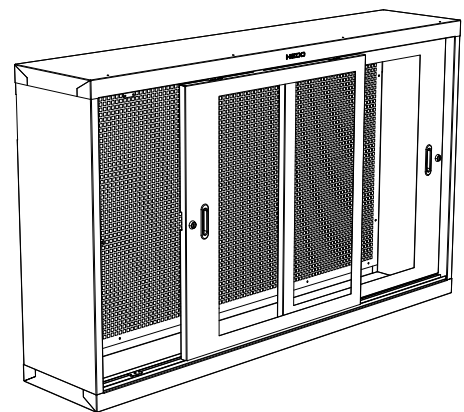

		L x A x H
110 15 PC P	64,8 Kg	1500 x 320 x 900

accesorios / accessoires / accessories		
145 15 1	soportes / supports / supports	3,2 Kg
1x	141 0 10/141 0 12/141 0 14/141 0 17/ 141 0 18/141 0 19/141 0 23	
5x	141 0 01/141 0 02/141 0 03/141 0 04	
<b>27u</b>	total soportes/total supports/total supports	



SERIE 110 PV

ARMARIOS CON PUERTAS ARMOIRES A PORTES DOORS CABINETS

Puertas de metacrilato.  
Portes en méthacrylate.  
Methacrylathe doors.

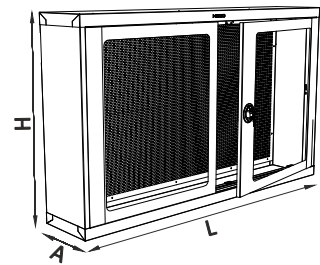

SOPORTES SUPPORTS / SUPPORTS

SERIE 141

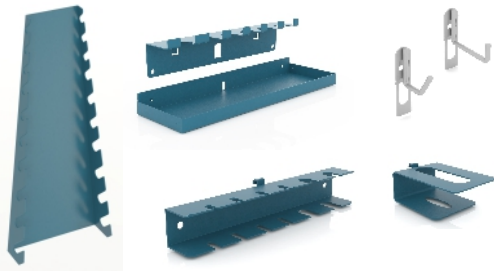

Ver información (PAG. 283).  
Voir information (PAG. 283).  
See information (PAG. 283).

		L x A x H (mm)
110 10 PV	36,5 Kg	1000x170x900
110 15 PV	64,8 Kg	1500x170x900

- e** 1,5 mm panel panneau/panel
- e** 1 mm estructura chassis/frame
- e** 0,6 mm puertas portes/doors

SERIE 110 10 PV STANDARD

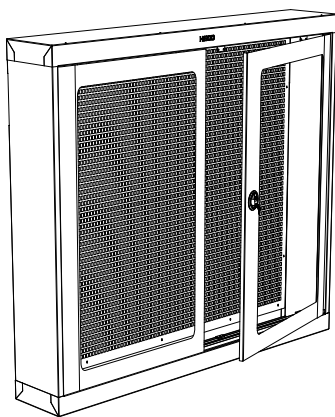

		L x A x H
110 10 PV	36,5 Kg	1000 x 170 x 900

accesorios / accessoires / accessories			
<b>145 10 1</b>	soportes / supports / supports	2,4 Kg	
1x	141 0 10/141 0 14/141 0 17/ 141 0 18/141 0 19		
3x	141 0 01/141 0 02/141 0 03/141 0 04		
<b>17u</b>	total soportes/total supports/total supports		

SERIE 110 15 PV STANDARD

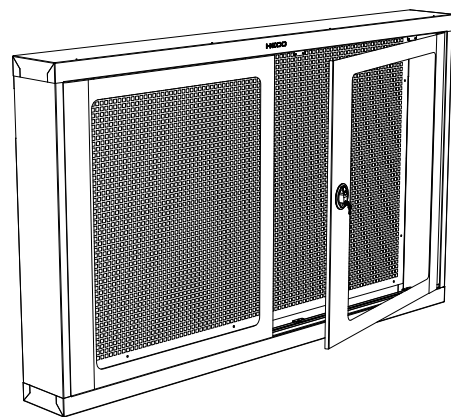

		L x A x H
110 15 PV	64,8 Kg	1500 x 170 x 900

accesorios / accessoires / accessories			
<b>145 15 1</b>	soportes / supports / supports	3,2 Kg	
1x	141 0 10/141 0 12/141 0 14/141 0 17/ 141 0 18/141 0 19/141 0 23		
5x	141 0 01/141 0 02/141 0 03/141 0 04		
<b>27u</b>	total soportes/total supports/total supports		

SERIE 110 PC C

ARMARIOS CON PUERTAS ARMOIRES A PORTES DOORS CABINETS

Puertas correderas de metacrilato.  
Portes coulissantes en méthacrylate.  
Sliding doors in methacrylate.

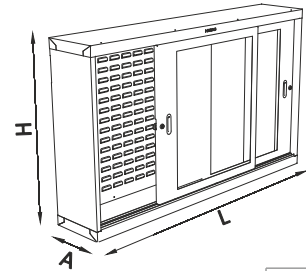

		L x A x H (mm)
110 10 PC C	50 Kg	1000x320x900
110 15 PC C	53 Kg	1500x320x900

CUBETAS BACS À BEC / TRAYS

SERIE V-BULL

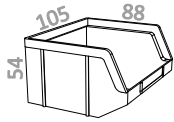

V-BULL 1 0,4 l

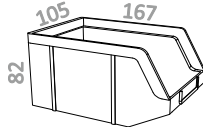

V-BULL 2 1,2 l

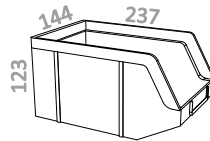

V-BULL 3 3,5 l



Ver información (PAG. 302).  
Voir information (PAG. 302).  
View information (PAG. 302).

- 1,5 mm panel panneau/panel
- 0,6 mm puertas portes/doors
- 1/0,8 mm estructura chassis/frame



Con panel porta cubetas.  
Avec panneau pour bacs à bec.  
With panel for trays.

SERIE 110 10 PC C STANDARD

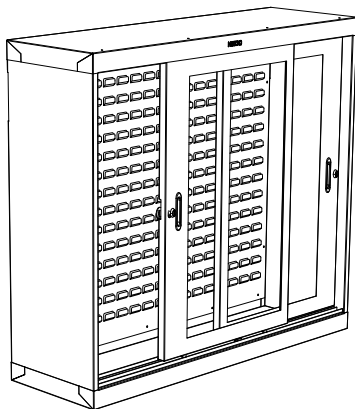

		L x A x H
110 10 PC C	50 Kg	1000 x 320 x 900

SERIE 110 15 PC C STANDARD

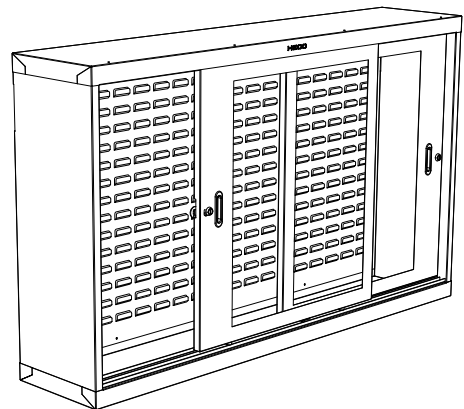

		L x A x H
110 15 PC C	53 Kg	1500 x 320 x 900



SERIE 110 PC C STANDARD

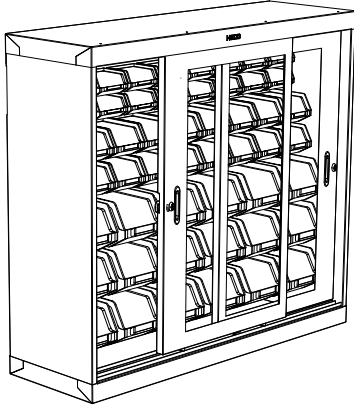

110 10 PC C 1	63 Kg	L x A x H 1000 x 320 x 900
---------------	-------	-------------------------------

componentes / composants / composants	
V-BULL 1	18 cubetas / 18 bacs à bec / 18 trays
V-BULL 2	18 cubetas / 18 bacs à bec / 18 trays
V-BULL 3	18 cubetas / 18 bacs à bec / 18 trays

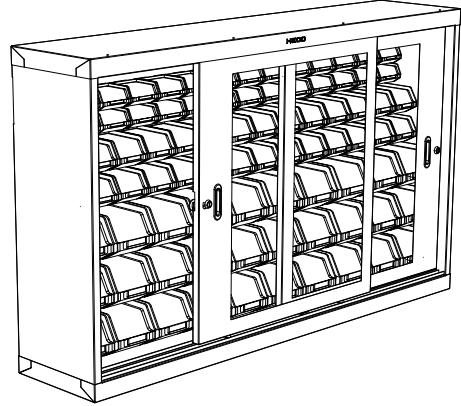

110 15 PC C 1	68 Kg	L x A x H 1500 x 320 x 900
---------------	-------	-------------------------------

componentes / composants / composants	
V-BULL 1	28 cubetas / 28 bacs à bec / 28 trays
V-BULL 2	28 cubetas / 28 bacs à bec / 28 trays
V-BULL 3	30 cubetas / 30 bacs à bec / 30 trays

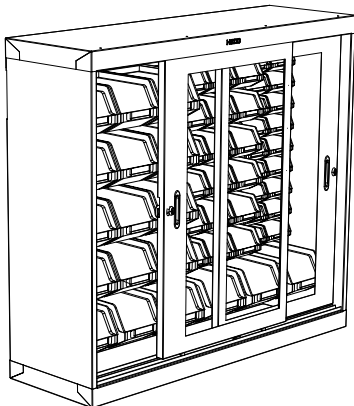

110 10 PC C 2	63 Kg	L x A x H 1000 x 320 x 900
---------------	-------	-------------------------------

componentes / composants / composants	
V-BULL 1	22 cubetas / 22 bacs à bec / 22 trays
V-BULL 2	18 cubetas / 18 bacs à bec / 18 trays
V-BULL 3	18 cubetas / 18 bacs à bec / 18 trays

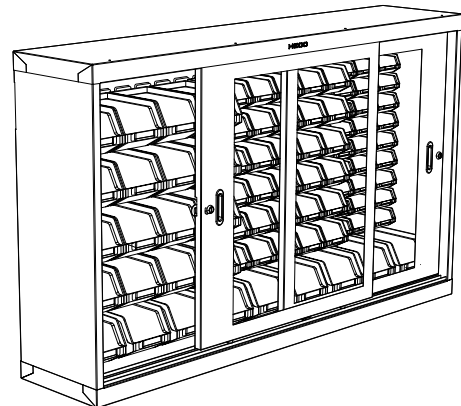

110 15 PC C 2	68 Kg	L x A x H 1500 x 320 x 900
---------------	-------	-------------------------------

componentes / composants / composants	
V-BULL 1	33 cubetas / 33 bacs à bec / 33 trays
V-BULL 2	30 cubetas / 30 bacs à bec / 30 trays
V-BULL 3	26 cubetas / 26 bacs à bec / 26 trays

SERIE V-BULL CUBETAS BACS A BEG TRAYS

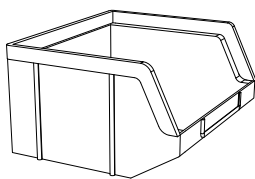

0,41

V-BULL 1	0,046 Kg	L x A x H 105 x 88 x 54
----------	----------	----------------------------

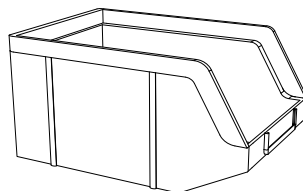

1,21

V-BULL 2	0,110 Kg	L x A x H 105 x 167 x 82
----------	----------	-----------------------------

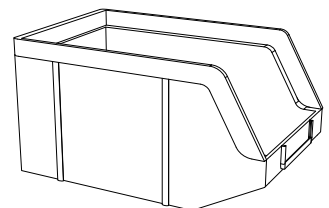

3,51

V-BULL 3	0,226 Kg	L x A x H 144 x 237 x 123
----------	----------	------------------------------

V-640 H ref. V-640 / V 640 H

SERIE V

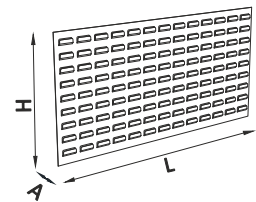
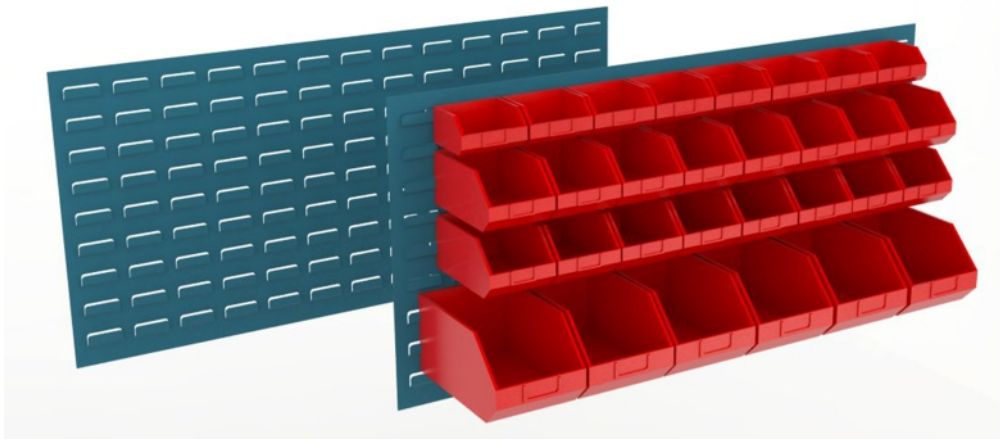

CUBETAS BACS A BEC / TRA

SERIE V-BULL

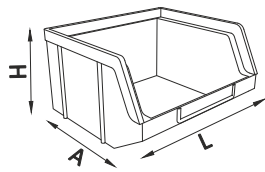

		L x A x H	color couleur / color	
V-BULL 1	0,046 Kg	105 x 88 x 54		
V-BULL 2	0,110 Kg	105 x 167 x 82		
V-BULL 3	0,226 Kg	144 x 237 x 123		

		L x A x H (mm)
V-640 H 1	6 Kg	500x10/12x480
V-640 H 2	10 Kg	990x10/12x480
V-640 H 3	10 Kg	500x10/12x980

1,2 mm



Para cubetas V-BULL.  
Pour bacs à bec V-BULL.  
For trays V-BULL.

SERIE V-640 H STANDARD

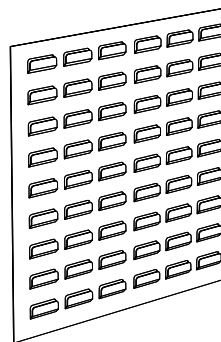

		L x A x H
V-640 H 1	6 Kg	500 x 10/12 x 480

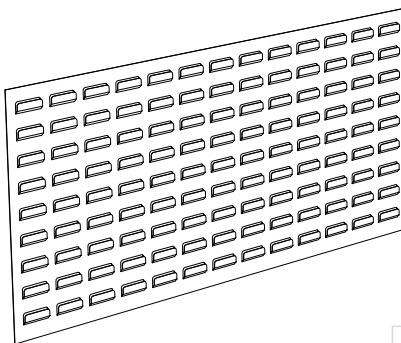

		L x A x H
V-640 H 2	10 Kg	990 x 10/12 x 480

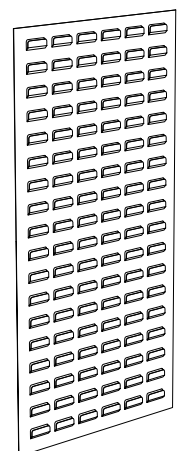

		L x A x H
V-640 H 3	10 Kg	500 x 10/12 x 980



SERIE V-640 H 1 STANDARD

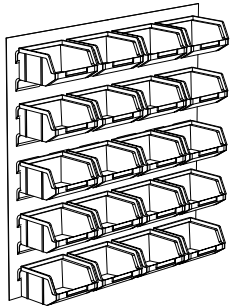

L x A x H		
V-640 H 1 20	3,9 Kg	500 x 100 x 480

componentes / composants / components  
 V-BULL 1 20 cubetas / 20 bacs à bec / 20 trays

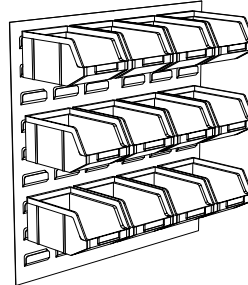

L x A x H		
V-640 H 1 12	4,4 Kg	500 x 180 x 480

componentes / composants / components  
 V-BULL 2 12 cubetas / 12 bacs à bec / 12 trays

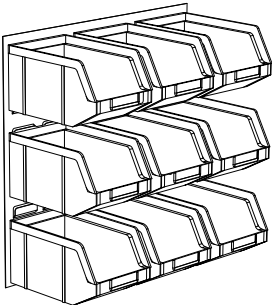

L x A x H		
V-640 H 1 09	5,1 Kg	500 x 250 x 480

componentes / composants / components  
 V-BULL 3 9 cubetas / 9 bacs à bec / 9 trays

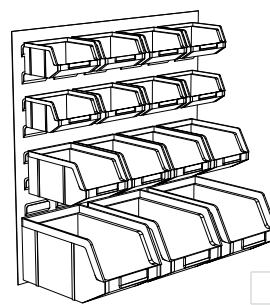

L x A x H		
V-640 H 1 15	4,5 Kg	500 x 250 x 480

componentes / composants / components  
 V-BULL 1 8 cubetas / 8 bacs à bec / 8 trays  
 V-BULL 2 4 cubetas / 4 bacs à bec / 4 trays  
 V-BULL 3 3 cubetas / 3 bacs à bec / 3 trays

SERIE V-640 H 2 STANDARD

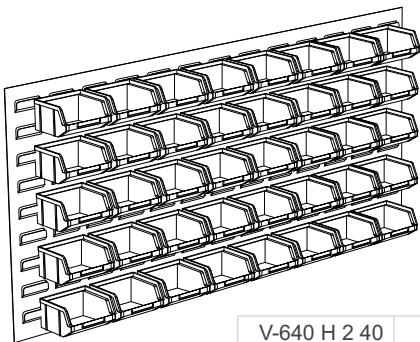

L x A x H		
V-640 H 2 40	7 Kg	990 x 100 x 480

componentes / composants / components  
 V-BULL 1 40 cubetas / 40 bacs à bec / 40 trays

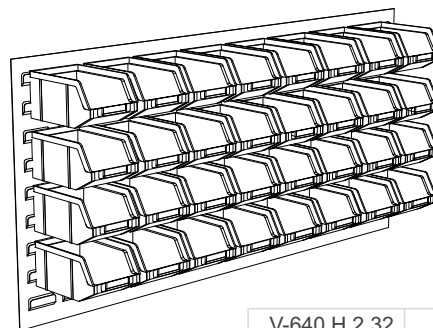

L x A x H		
V-640 H 2 32	9 Kg	990 x 180 x 480

componentes / composants / components  
 V-BULL 2 32 cubetas / 32 bacs à bec / 32 trays

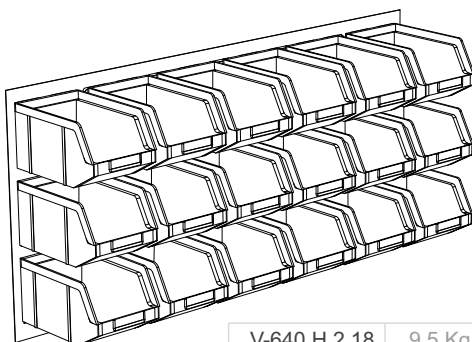

L x A x H		
V-640 H 2 18	9,5 Kg	990 x 250 x 480

componentes / composants / components  
 V-BULL 3 18 cubetas / 18 bacs à bec / 18 trays

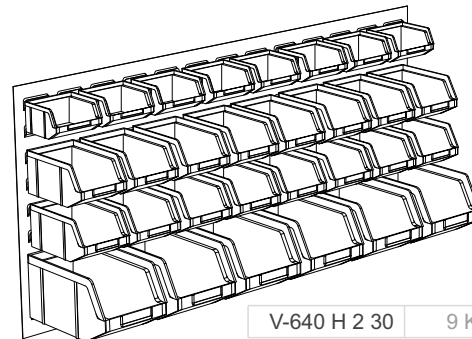

L x A x H		
V-640 H 2 30	9 Kg	990 x 250 x 480

componentes / composants / components  
 V-BULL 1 8 cubetas / 8 bacs à bec / 8 trays  
 V-BULL 2 16 cubetas / 16 bacs à bec / 16 trays  
 V-BULL 3 6 cubetas / 6 bacs à bec / 6 trays

SERIE V-640 H 3 STANDARD

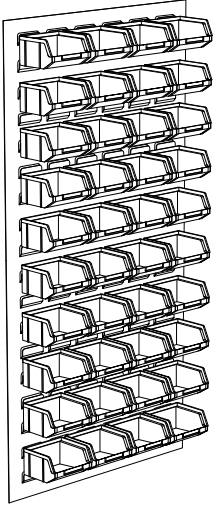

		L x A x H
V-640 H 3 40	10 Kg	500 x 100 x 980

componentes / composants / components	
V-BULL 1	40 cubetas / 40 bacs à bec / 40 trays

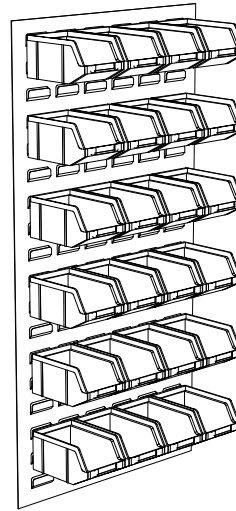

		L x A x H
V-640 H 3 24	8 Kg	500 x 180 x 980

componentes / composants / components	
V-BULL 2	24 cubetas / 24 bacs à bec / 24 trays

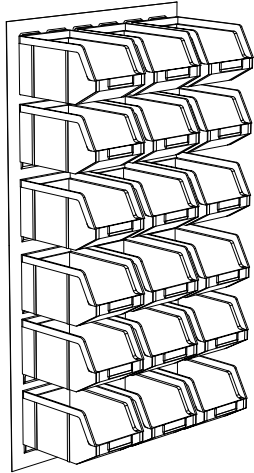

		L x A x H
V-640 H 3 18	9,5 Kg	500 x 250 x 980

componentes / composants / components	
V-BULL 3	18 cubetas / 18 bacs à bec / 18 trays

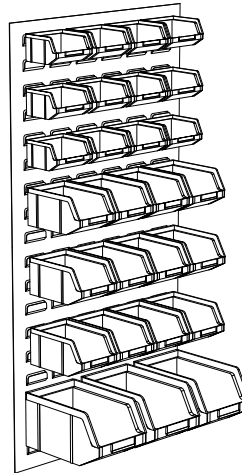

		L x A x H
V-640 H 3 27	8 Kg	500 x 250 x 980

componentes / composants / components	
V-BULL 1	12 cubetas / 12 bacs à bec / 12 trays
V-BULL 2	12 cubetas / 12 bacs à bec / 12 trays
V-BULL 3	3 cubetas / 3 bacs à bec / 3 trays

SERIE V-940 STANDARD

PANEL DE PLASTICO PANNEAU DE PLASTIQUE / PLASTIC PANEL

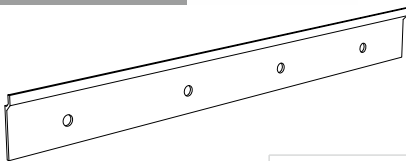

	L x H
V-940	415 x 45

composición / composition / composition	
V-940	soporte / support / support

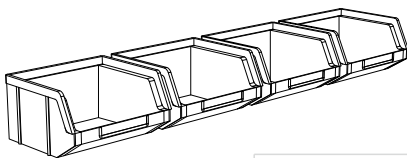

	L x A x H
V-940 1	415 x 100 x 54

composición / composition / composition	
V-940	soporte / support / support
V-BULL 1	4 cubetas / 4 bacs à bec / 4 trays

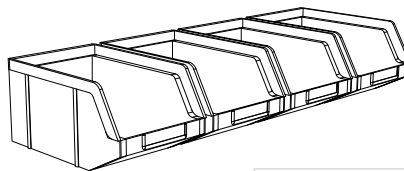

	L x A x H
V-940 2	415 x 180 x 82

composición / composition / composition	
V-940	soporte / support / support
V-BULL 2	4 cubetas / 4 bacs à bec / 4 trays

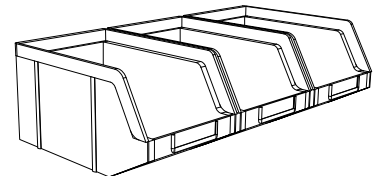

	L x A x H
V-940 3	415 x 250 x 123

composición / composition / composition	
V-940	soporte / support / support
V-BULL 3	3 cubetas / 3 bacs à bec / 3 trays





SERIE V-640 STANDARD

PLASTICO PLASTIQUE / PLASTIC

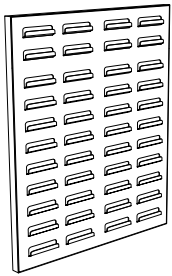

L x A x H		
V-640	0,2 Kg	340 x 20 x 400

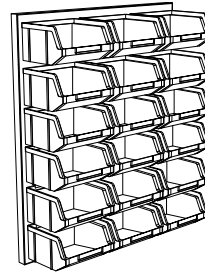

L x A x H		
V-640 1	1,1 Kg	340 x 100 x 400

componentes / composants / components		
V-BULL 1	18 cubetas / 18 bacs à bec / 18 trays	

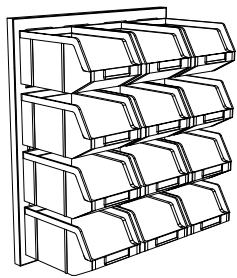

L x A x H		
V-640 2	1,5 Kg	340 x 180 x 400

componentes / composants / components		
V-BULL 2	12 cubetas / 12 bacs à bec / 12 trays	

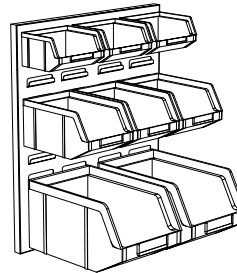

L x A x H		
V-640 M	1,2 Kg	340 x 250 x 400

componentes / composants / components		
V-BULL 1	3 cubetas / 3 bacs à bec / 3 trays	
V-BULL 2	3 cubetas / 3 bacs à bec / 3 trays	
V-BULL 3	2 cubetas / 2 bacs à bec / 2 trays	

V-401 ref. V-401 / V-402

SERIE V

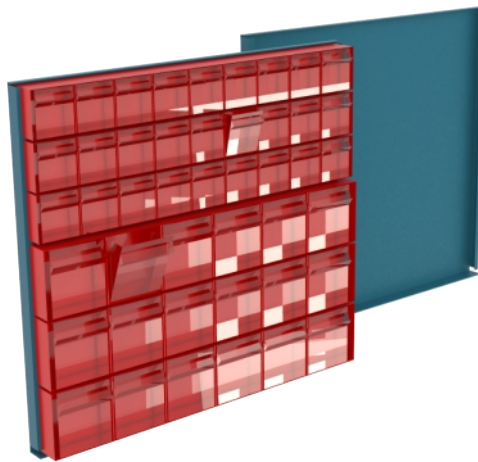

CUBETAS CASIERS / TRAYS

SERIE V-FOX

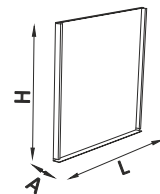
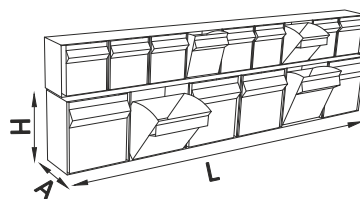
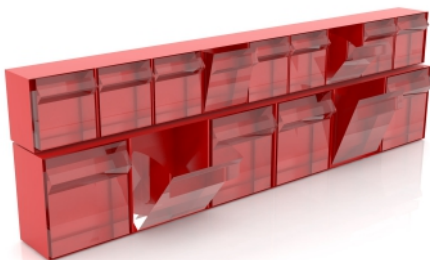

		L x A x H	color couleur / color	
V-FOX 101	9 u	600 x 68 x 76		
V-FOX 102	6 u	600 x 94 x 112		
V-FOX 103	5 u	600x 135 x 164		
V-FOX 104	4 u	600 x 177 x 206		

		L x A x H (mm)
V-401	11,5 Kg	2 603x30x560
V-402	14,5 Kg	2 603x60x800

1,2 mm



Para cubetas V-FOX.  
Pour bacs à bec V-FOX.  
For trays V-FOX.

SERIE V-401 STANDARD

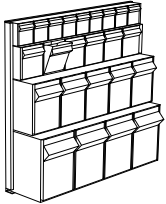

		L x A x H
V-401 H 1	12,43 Kg	603 x 177 x 560
componentes / composants / components		
V-FOX 101	1 cubeta / 1 casier / 1 tray	
V-FOX 102	1 cubeta / 1 casier / 1 tray	
V-FOX 103	1 cubeta / 1 casier / 1 tray	
V-FOX 104	1 cubeta / 1 casier / 1 tray	

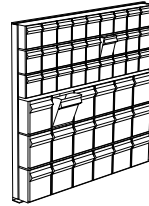

		L x A x H
V-401 H 4	11,19 Kg	603 x 94 x 560
componentes / composants / components		
V-FOX 101	3 cubetas / 3 casiers / 3 trays	
V-FOX 102	3 cubetas / 3 casiers / 3 trays	

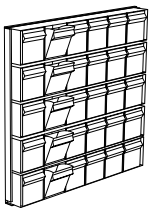

		L x A x H
V-401 H 2	11,40 Kg	603 x 94 x 560
componentes / composants / components		
V-FOX 102	5 cubetas / 5 casiers / 5 trays	

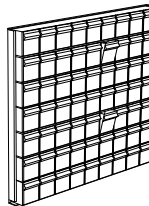

		L x A x H
V-401 H 5	10,55 Kg	603 x 68 x 560
componentes / composants / components		
V-FOX 101	7 cubetas / 7 casiers / 7 trays	



		L x A x H
V-401 H 3	11,96 Kg	603 x 135 x 560
componentes / composants / components		
V-FOX 102	2 cubetas / 2 casiers / 2 trays	
V-FOX 103	2 cubetas / 2 casiers / 2 trays	

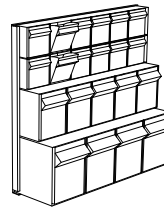

		L x A x H
V-401 H 6	12,86 Kg	603 x 177 x 560
componentes / composants / components		
V-FOX 102	2 cubetas / 2 casiers / 2 trays	
V-FOX 103	1 cubeta / 1 casier / 1 tray	
V-FOX 104	1 cubeta / 1 casier / 1 tray	

SERIE V-402 STANDARD

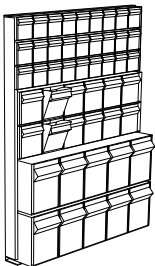

		L x A x H
V-402 H 1	15,21 Kg	603 x 135 x 800
componentes / composants / components		
V-FOX 101	3 cubetas / 3 casiers / 3 trays	
V-FOX 102	2 cubetas / 2 casiers / 2 trays	
V-FOX 103	2 cubetas / 2 casiers / 2 trays	

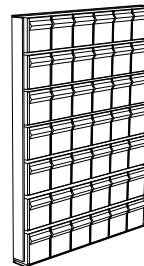

		L x A x H
V-402 H 4	14,86 Kg	603 x 94 x 800
componentes / composants / components		
V-FOX 102	7 cubetas / 7 casiers / 7 trays	

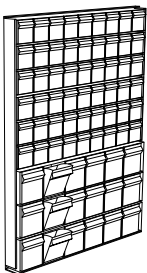

		L x A x H
V-402 H 2	14,46 Kg	603 x 94 x 800
componentes / composants / components		
V-FOX 101	6 cubetas / 6 casiers / 6 trays	
V-FOX 102	3 cubetas / 3 casiers / 3 trays	

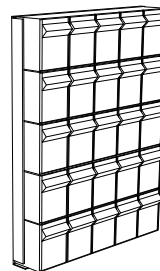

		L x A x H
V-402 H 5	16,8 Kg	603 x 135 x 800
componentes / composants / components		
V-FOX 103	5 cubetas / 5 casiers / 5 trays	

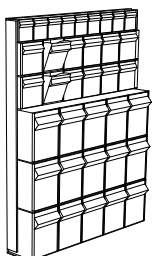

		L x A x H
V-402 H 3	15,81 Kg	603 x 135 x 800
componentes / composants / components		
V-FOX 101	1 cubetas / 1 casier / 1 trays	
V-FOX 102	2 cubetas / 2 casiers / 2 trays	
V-FOX 103	3 cubetas / 3 casiers / 3 trays	

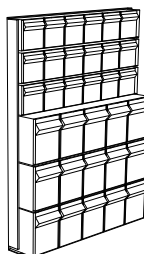

		L x A x H
V-402 H 6	16,24 Kg	603 x 135 x 800
componentes / composants / components		
V-FOX 102	3 cubetas / 3 casiers / 3 trays	
V-FOX 103	3 cubetas / 3 casiers / 3 trays	